

# Errata

This manual may contain references to HP or Hewlett-Packard. Please note that Hewlett-Packard's former test and measurement, semiconductor products and chemical analysis businesses are now part of Agilent Technologies. To reduce potential confusion, the only change to product numbers and names has been in the company name prefix: where a product number/name was HP XXXX the current name/number is now Agilent XXXX. For example, model number HP8648 is now model number Agilent 8648.

Ce manuel peut contenir des références à <<HP>> ou <<Hewlett-Packard.>> Veuillez noter que les produits de test et mesure, de semi-conducteur et d'analyse chimique qui avaient fait partie de la société Hewlett-Packard sont maintenant une partie de la société Agilent Technologies. Pour réduire la confusion potentielle, le seul changement aux noms de référence a été dans le préfixe de nom de société : là où un nom de référence était HP XXXX, le nouveau nom de référence est maintenant Agilent XXXX. Par exemple, le HP 8648 s'appelle maintenant Agilent 8648.

Diese Gebrauchsanweisung kann Bezug nehmen auf die Namen HP oder Hewlett-Packard. Bitte beachten Sie, dass ehemalige Betriebsbereiche von Hewlett-Packard wie HP-Halbleiterprodukte, HP-chemische Analysen oder HP-Test- und Messwesen nun zu der Firma Agilent Technology gehören. Um Verwirrung zu vermeiden wurde lediglich bei Produktname und - Nummer der vor laufende Firmenname geändert: Produkte mit dem Namen/Nummer HP XXXX lauten nun mehr Agilent XXXX. Z.B. das Modell HP 8648 heißt nun Agilent 8648.

Questo manuale potrebbe contenere riferimenti ad HP o Hewlett-Packard. Si noti che le attività precedentemente gestite da Hewlett-Packard nel campo di Test & Misura, Semiconduttori, ed Analisi Chimica sono ora diventate parte di Agilent Technologies. Al fine di ridurre il rischio di confusione, l'unica modifica effettuata sui numeri di prodotto e sui nomi ha riguardato il prefisso con il nome dell'azienda : dove precedentemente compariva "HP XXXX" compare ora "Agilent XXXX". Ad esempio: il modello HP8648 è ora indicato come Agilent 8648.

Este manual puede hacer referencias a HP o Hewlett Packard. Las organizaciones de Prueba y Medición (Test and Measurement), Semiconductores (Semiconductor Products) y Análisis Químico (Chemical Analysis) que pertenecían a Hewlett Packard, ahora forman parte de Agilent Technologies. Para reducir una potencial confusión, el único cambio en el número de producto y nombre, es el prefijo de la compañía: Si el producto solía ser HP XXXX, ahora pasa a ser Agilent XXXX. Por ejemplo, el modelo HP8648 es ahora Agilent 8648.

这个手册里面可能含有惠普公司的资料。请注意惠普公司以前的测试, 半导体产品, 化学分析部门现在属于安捷伦公司。为了减少可能的误解, 产品号码和名字只改变最前面的公司名字。如果一个产品的号码/名字以前是HP XXXX, 现在的号码/名字是安捷伦 XXXX。例如模型号码是惠普8648。现在是模型号码安捷伦8648。

Document Part Number 5971-2669  
Printed in the UK September 2004



**Agilent Technologies**

## マニュアル・チェンジ

### 変更

本文中の「HP (YHP)」、または「(横河)ヒューレット・パッカー株式会社」という語句を、「Agilent」、または「アジレント・テクノロジー株式会社」と変更してください。

ヒューレット・パッカー社の電子計測、半導体製品、化学分析ビジネス部門は分離独立し、アジレント・テクノロジー社となりました。

社名変更に伴うお客様の混乱を避けるため、製品番号の接頭部のみ変更しております。

(例: 旧製品名 HP 4294A は、現在 Agilent 4294A として販売いたしております。)

**HP 8900D Peak Power Meter**

# **Operating and Service Manual**



**HP Part No. 08900-900249  
Printed in UK  
June 1998**

© Copyright Hewlett-Packard Ltd. 1998

## Notice

The information contained in this document is subject to change without notice.

Hewlett-Packard makes no warranty of any kind with regard to this material, including but not limited to, the implied warranties of merchantability and fitness for a particular purpose. Hewlett-Packard shall not be liable for errors contained herein or for incidental or consequential damages in connection with the furnishing, performance, or use of this material.

This manual applies to instruments with serial numbers prefixed 3607U and below. With the changes in the Appendix added, this manual applies to instruments with serial numbers prefixed 1314A, 1551A.

© Copyright Hewlett-Packard Ltd. 1998.  
All Rights Reserved. Reproduction, adaptation, or translation without prior written permission is prohibited, except as allowed under the copyright laws. Station Road, South Queensferry, Scotland, EH30 9TG, UK.

---

## Warranty

This Hewlett-Packard product is warranted against defects in materials and workmanship for a period of one year from date of shipment. During the warranty period, Hewlett-Packard Company will, at its option, either repair or replace products which prove to be defective.

For warranty service or repair, this product must be returned to a service facility designated by HP. Buyer shall prepay shipping charges to HP and HP shall pay shipping charges to return the product to Buyer. However, Buyer shall pay all shipping charges, duties, and taxes for products returned to HP from another country.

---

## Limitation of Warranty

The foregoing warranty shall not apply to defects resulting from:

- 1 Improper or inadequate maintenance, adjustment, calibration, or operation by Buyer;
- 2 Buyer-supplied software, hardware, interfacing or consumables;
- 3 Unauthorized modification or misuse;
- 4 Operation outside of the environmental and electrical specifications for the product;
- 5 Improper site preparation and maintenance; or
- 6 Customer induced contamination or leaks.

THE WARRANTY SET FORTH IS EXCLUSIVE AND NO OTHER WARRANTY, WHETHER WRITTEN OR ORAL, IS EXPRESSED OR IMPLIED. HP SPECIFICALLY DISCLAIMS THE IMPLIED WARRANTIES OF MERCHANTABILITY AND FITNESS FOR A PARTICULAR PURPOSE.

---

## Limitation of Remedies and Liability

THE REMEDIES PROVIDED HEREIN ARE BUYER'S SOLE AND EXCLUSIVE REMEDIES. IN NO EVENT SHALL HP BE LIABLE FOR DIRECT, INDIRECT, SPECIAL, INCIDENTAL, OR CONSEQUENTIAL DAMAGES (INCLUDING LOSS OF PROFITS) WHETHER BASED ON CONTRACT, TORT OR ANY OTHER LEGAL THEORY.

## Declaration of Conformity

## Declaration of Conformity

<b>Declaration of Conformity</b> according to ISO/IEC Guide 22 and EN45014	
<b>Manufacturer's Name:</b>	<b>Hewlett-Packard Ltd.</b>
<b>Manufacturer's Address:</b>	Queensferry Microwave Division South Queensferry West Lothian, EH30 9TG Scotland, United Kingdom
Declares that the product	
<b>Product Name:</b>	Analog Peak POWER Meter
<b>Model Numbers:</b>	HP 8900D
<b>Product Options:</b>	This declaration covers all options of the above products as detailed in TCF A-5951-9852-02
Conforms with the protection requirements of European Council Directive 89/336/EEC on the approximation of the laws of the member states relating to electromagnetic compatibility.	
Against EMC test specifications EN 55011:1991 (Group 1, Class A) and EN 50082-1:1992	
<b>As Detailed in:</b>	Electromagnetic Compatibility (EMC) Technical Construction File (TCF) No. A-5951-9852-02
<b>Assessed by:</b>	Dti Appointed Competent Body EMC Test Centre, GEC-Marconi Avionics Ltd., Maxwell Building, Donibristle Industrial Park, KY11 5LB Scotland, United Kingdom
Technical Report Number:6893/2200/CBR, dated 23 September 1997	
<b>Supplementary Information:</b>	The product conforms to the following safety standards: EN 61010-1(1993) / IEC 1010-1(1990) +A1(1992) CSA-C22.2 No. 1010.1-92
The product herewith complies with the requirements of the Low Voltage Directive 73/23/EEC, and carries the CE-marking accordingly.	
<i>South Queensferry, Scotland</i>	<b>19 January 1998</b> <i>R M Evans</i>
<i>Location</i>	<i>Date</i> <i>R.M. Evans / Quality Manager</i>

Europe Contact:

Your local Hewlett-Packard Sales and Service Office or Hewlett-Packard GmbH, Department 2Q/  
Standards Europe Herrenberger Strasse 130, D7030 Boblinger (Fax: +49-7031-143143)

## Statement of Compliance

### **Electromagnetic Compatibility (EMC) Information**

This product has been designed to meet the protection requirements of the European Communities Electromagnetic Compatibility (EMC) directives:

- EN55011:1991 (Group 1, Class A)
- EN50082-1:1992
- IEC 1000-4-2 (1995) ESD
- IEC 1000-4-3 (1995) Radiated Susceptibility
- IEC 1000-4-4 (1995) EFT

In order to preserve the EMC performance of the product, any cable which becomes worn or damaged must be replaced with the same type and specification.

### **Safety Information**

This instrument has been designed and tested in accordance with publication EN61010-1(1993) / IEC 1010-1(1990) +A1(1992) +A2(1994) / CSA C22.2 No. 1010.1(1993) Safety Requirements for Electrical Equipment for Measurement, Control and Laboratory Use, and has been supplied in a safe condition. The instruction documentation contains information and warnings which must be followed by the user to ensure safe operation and to maintain the instrument in a safe condition.

---

## Noise Declaration

LpA<70dB

am Arbeitsplatz (operator position)

normaler Betrieb (normal position)

nach DIN 45635 pt.19 (per ISO 7779)

## General Safety Information

The following general safety precautions must be observed during all phases of operation, service, and repair of this instrument. Failure to comply with these precautions or with specific warnings elsewhere in this manual violates safety standards of design, manufacture, and intended use of the instrument. Hewlett-Packard Company assumes no liability for the customer's failure to comply with these requirements.

### **WARNING**

This is a Safety Class I instrument (provided with a protective earthing ground, incorporated in the powercord). The mains plug shall only be inserted in a socket outlet provided with a protective earth contact. Any interruption of the protective conductor inside or outside of the instrument is likely to make the instrument dangerous. Intentional interruption is prohibited.

DO NOT operate the product in an explosive atmosphere or in the presence of flammable gasses or fumes.

DO NOT use repaired fuses or short-circuited fuseholders: For continued protection against fire, replace the line fuse(s) only with fuse(s) of the same voltage and current rating and type.

DO NOT perform procedures involving cover or shield removal unless you are qualified to do so: Operating personnel must not remove equipment covers or shields. Procedures involving the removal of covers and shields are for use by service-trained personnel only.

DO NOT service or adjust alone: Under certain conditions, dangerous voltages may exist even with the equipment switched off. To avoid dangerous electrical shock, service personnel must not attempt internal service or adjustment unless another person, capable of rendering first aid and resuscitation, is present.

DO NOT operate damaged equipment: Whenever it is possible that the safety protection features built into this product have been impaired, either through physical damage, excessive moisture, or any other reason, REMOVE POWER and do not use the product until safe operation can be verified by service-trained personnel. If necessary, return the product to a Hewlett-Packard Sales and Service Office for service and repair to ensure the safety features are maintained.









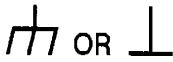

DO NOT substitute parts or modify equipment: Because of the danger of introducing additional hazards, do not install substitute parts or perform any unauthorized modification to the product. Return the product to a Hewlett-Packard Sales and Service Office for service and repair to ensure the safety features are maintained.

---

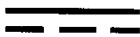

**Safety Symbols**

The following symbols on the instrument and in the manual indicate precautions which must be taken to maintain safe operation of the instrument.

<b>Safety Symbols</b>	
	The Instruction Documentation Symbol. The product is marked with this symbol when it is necessary for the user to refer to the instructions in the supplied documentation.
	Indicates the field wiring terminal that must be connected to earth ground before operating the equipment - protects against electrical shock in case of fault.
	Frame or chassis ground terminal - typically connects to the equipment's metal frame.
	Alternating current (AC)
	Direct current (DC)
	Indicates hazardous voltages
	Warning denotes a hazard. It calls attention to a procedure, which if not correctly performed or adhered to could result in injury or loss of life. Do not proceed beyond a warning note until the indicated conditions are fully understood and met.
	Caution denotes a hazard. It calls attention to a procedure, which if not correctly performed or adhered to could result in damage to or destruction of the instrument. Do not proceed beyond a caution note until the indicated conditions are fully understood and met.
	The CE mark shows that the product complies with all relevant European Legal Directives.
ISM 1-A	This is a symbol of an Industrial, Scientific, and Medical Group 1 Class A product.
	The CSA mark is a registered trademark of the Canadian Standards Association, and indicates compliance to the standards layed out by them.
	Indicates easily touched higher temperature parts.

# CONTENTS

	Page	1
<b>Section I</b>		
<b>GENERAL INFORMATION</b>		
Introduction .....	1-1	
Specifications .....	1-1	
Safety Considerations .....	1-1	
Instruments Covered by Manual .....	1-1	
Description .....	1-2	
Accessories Supplied .....	1-2	
Equipment Required but not Supplied .....	1-2	
Recommended Test Equipment .....	1-2	
<b>Section II</b>		
<b>INSTALLATION</b>		
Introduction .....	2-1	
Initial Inspection .....	2-1	
Preparation For Use .....	2-1	
Power Requirements .....	2-1	
Line Voltage and Fuse Selection .....	2-1	
Power Cables .....	2-1	
Interconnections .....	2-2	
Mating Connectors .....	2-2	
Operating Environment .....	2-2	
Operator Maintenance .....	2-2	
Bench Operation .....	2-3	
Storage and Shipment .....	2-3	
Storage Environment .....	2-3	
Packaging .....	2-3	
<b>Section III</b>		
<b>OPERATION</b>		
Introduction .....	3-1	
Panel Features .....	3-1	
Operating Instructions .....	3-1	
Power Measurement Accuracy .....	3-1	
Sources of Error and Measurement		
Uncertainty .....	3-1	
RF Losses .....	3-1	
Mismatch .....	3-1	
Instrumentation Uncertainty .....	3-1	
Specified Uncertainties .....	3-1	
Calculating Mismatch Uncertainty .....	3-1	
Corrections for Error .....	3-2	
Correction Factor .....	3-2	
Transfer Function of the Diode Current		
Versus Input Voltage .....	3-2	
Operator's Maintenance .....	3-2	
Power Line Fuse .....	3-2	
Lamp Replacement .....	3-2	
Operating Instructions .....	3-6	
Direct Mode .....	3-6	
Compare Mode .....	3-6	
Calculating Measurement Uncertainty .....		
Calculating Measurement Uncertainty		
when Uncertainty in dB is Known .....		
<b>Section IV</b>		
<b>PERFORMANCE TESTS</b>		
Introduction .....		
Equipment Required .....		
Performance Test Record .....		
Performance Tests .....		
Peak Power Sensor Performance Test		
(Return Loss) .....		
Peak Power Measurement System		
Performance Tests .....		
<b>Section V</b>		
<b>ADJUSTMENTS</b>		
Introduction .....		
Equipment Required .....		
Peak Power Meter Adjustments .....		
<b>Section VI</b>		
<b>REPLACEABLE PARTS</b>		
Introduction .....		
Abbreviations .....		
Replaceable Parts List .....		
Ordering Instruction .....		
Parts Provisioning .....		
Spare Parts Kit .....		
Recommended Spares List .....		
<b>Section VII</b>		
<b>MANUAL CHANGES</b>		
Introduction .....		
<b>Section VIII</b>		
<b>SERVICE</b>		
Introduction .....		
Service Sheets .....		
Block Diagram .....		
Schematic Diagrams .....		
Principles of Operation .....		
Troubleshooting .....		
Recommended Test Equipment .....		
Service Aids .....		
Posidriv Screwdrivers .....		
Servicing Aids on Printed		
Circuit Boards .....		

## ILLUSTRATIONS

Figure	Page	Figure	Page
1-1. HP 8900C Peak Power Meter with Accessories Supplied .....	1-0	6-1. Cabinet Parts Illustrated Parts Breakdown .....	6
2-1. Line Voltage Selection .....	2-2	8-1. Troubleshooting Equipment Setup .....	8
2-2. Power Cables Available .....	2-2	8-2. Overall Block Diagram .....	8
3-1. Front Panel Controls, Indicators and Connectors .....	3-3	8-3. Motherboard Assembly Component Locations .....	8
3-2. Rear Panel Features .....	3-4	8-4. Switchboard Assembly Component Locations .....	8
3-3. Worst Case Effects of Specified and Mismatch Uncertainties .....	3-5	8-5. Motherboard Schematic Diagram .....	8
4-1. Peak Power Sensor Performance Test (Return Loss) .....	4-2	8-6. P/O Shaper Amplifier .....	8
4-2. CW Power Measurement Accuracy .....	4-5	8-7. Shaper Assembly Component Locations .....	8
4-3. Peak Power Measurement Accuracy .....	4-8	8-8. Switchboard Assembly Component Locations .....	8
		8-9. Shaper Schematic Diagram .....	8

## TABLES

Table	Page	Table	Page
1-1. Specifications .....	1-1	6-2. Replaceable Parts .....	
1-2. Supplemental Characteristics .....	1-2	6-3. Code List of Manufacturers .....	6
1-3. Recommended Test Equipment .....	1-3	8-1. Schematic Diagram Notes .....	
3-1. Power Line Fuse Information .....	3-2	8-2. 100 mW Shaper Amplifier Output Voltages .....	8
4-1. Performance Test Record .....	4-10	8-3. 10 mW Shaper Amplifier Output Voltages .....	8
6-1. Reference Designations and Abbreviations .....	6-2		

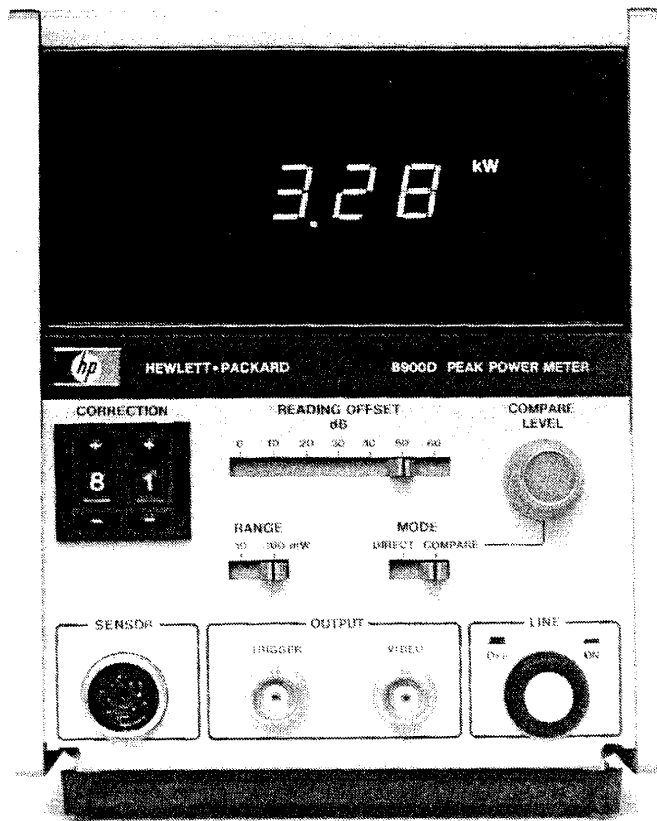

MODEL 8900D

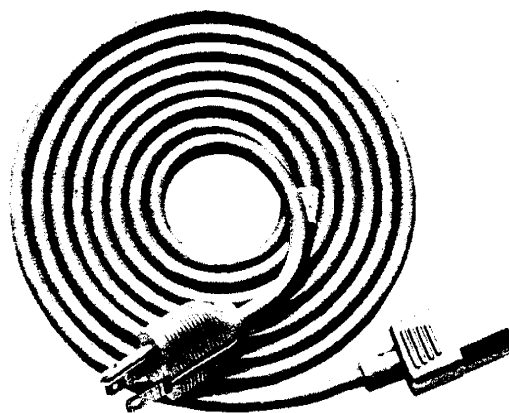

POWER CORD

Figure 1-1. 8900D Peak Power Meter

## SECTION I GENERAL INFORMATION

### 1-1. INTRODUCTION

This manual contains operating and service information for the Hewlett-Packard Model 8900D Peak Power Meter. The Peak Power Meter is shown in Figure 1-1 with its externally supplied accessory.

This section of the manual describes the instruments documented by this manual and covers instrument description, specifications and other basic information. The other sections provide the following:

- Section II—Installation
- Section III—Operation
- Section IV—Performance Tests
- Section V—Adjustments
- Section VI—Replaceable Parts
- Section VII—Manual Changes
- Section VIII—Service

### 1-2. SPECIFICATIONS

Instrument specifications are listed in Table 1-1. These specifications are the performance standards or limits against which the instrument can be tested.

### 1-3. SAFETY CONSIDERATIONS

Refer to the Safety Considerations page found at the beginning of this manual for a summary of general safety information.

Safety information for installation, operation, and servicing is found in appropriate places throughout this manual.

### 1-4. INSTRUMENTS COVERED BY MANUAL

This instrument has a two-part serial number. The first four digits and the letter are the serial number prefix which identifies the instrument configuration. The last five digits form the suffix that is unique to each instrument. The contents of this manual apply directly to instruments having the same serial number prefix(es) as listed under SERIAL NUMBERS on the title page.

An instrument manufactured after the printing of this manual may have a serial number prefix that is not listed on the title page. This unlisted prefix indicates that the instrument is different from those documented in this manual. The manual for this instrument is supplied with a Manual Changes supplement that contains change information that documents the differences.

**Table 1-1. Specifications**

<b>Frequency range:</b> 100 MHz to 18 GHz.			
<b>Dynamic range:</b> 20 dB (O to +20 dBm).			
<b>Range:</b> 4 ranges of 3, 10, 30 and 100 mW full scale.			
<b>Pulse Response</b>			
<b>Direct Mode</b>			
<b>Pulse width:</b> 1µs to CW.			
<b>Repetition rate:</b> 100 Hz to 100 kHz.			
<b>Compare mode</b>			
<b>Pulse width:</b> minimum width limited by rise time.			
<b>Repetition rate:</b> 0 to 100 kHz.			
<b>Rise time:</b> 75 ns.			
<b>Fall time:</b> 125 ns (as measured on video output).			
<b>Environmental</b>			
<b>Operating Temperature:</b> 0 to +55°C			
<b>Storage Temperature:</b> -40 to +70°C			
<b>Humidity:</b> Up to 95% Relative Humidity to 40°C			
<b>EMC:</b> Meets EN55011:1991 (Group1, Class A), and EN50082-1:1992			
<b>Physical</b>			
<b>Weight:</b> 2.7 kg (6lbs) nominal.			
<b>Dimensions (height x width x depth):</b> 165H x 130W x 292D (6.5 x 5.1 x 11.5 ins) nominal.			
<b>General</b>			
<b>Supply:</b> 100 and 120 Vac +5, -10%, 48-66 Hz and 360 - 440 Hz			
220 and 240 Vac +5, -10%, 48-66 Hz			
<b>Power:</b> 15W, 15VA maximum. (3W typical).			
Meter Accuracy <sup>1</sup>	CW	Pulse	Transfer Accuracy CW to Pulse <sup>3</sup>
Direct <sup>2</sup>	±0.2 dB	±0.35 dB	±0.2 dB
Compare	±0.2 dB	±0.25 dB	±0.1 dB
<sup>1</sup> Specifications only apply when used on appropriate range in combination with specifications of 8481 IA sensor. <sup>2</sup> Does not include errors due to source harmonics. <sup>3</sup> Error in reading pulsed power when meter is first calibrated with a known CW level. Eliminates sensor calibration error. (Mismatch errors and oscilloscope errors are not included.)			

**Table 1-2. Supplemental Characteristics**

**Recorder output:** 0–1 Vdc linearly proportional to the indicated power on each range. Output impedance 1 k $\Omega$ , BNC connector.

**Video output:** provides detected input signal and reference line used in compare mode. Not linear with power. Nominal impedance 50 $\Omega$ , BNC connector. Typical output voltage for 1 mW input 30 mV, dc coupled.

**Scope trigger output:** provides trigger signal for test oscilloscope. Typical output voltage >0.1V. Nominal impedance 50 $\Omega$ , BNC connector.

**1-5. DESCRIPTION**

The Hewlett-Packard Model 8900D Peak Power Meter directly displays the peak power of RF pulses over a 100 MHz to 18 GHz frequency range. Measurements can be made on pulses with widths from 1  $\mu$ s (100 ns in COMPARE mode) to CW, and repetition rates from 100 Hz (0 Hz in COMPARE mode) to 100 kHz. The dynamic range of the HP 8900D is 20 dB (0 to +20 dBm).

The HP 8900D has two modes of operation, DIRECT and COMPARE. In the DIRECT mode the Power Meter automatically captures and displays the peak power of the pulse. In the COMPARE mode an oscilloscope is used with the HP 8900D to measure power at any desired point on the pulse waveform.

**1-6. ACCESSORIES SUPPLIED**

The accessory supplied with the Peak Power Meter is shown in Figure 1-1. The line power cable will be supplied in one of several configurations, depending upon the country of destination for the original shipment from the factory. Refer to Power Cables in Section II of this manual.

**1-7. EQUIPMENT REQUIRED BUT NOT SUPPLIED**

To form a complete peak power measurement system, a power sensor such as the HP 84811A must be connected to the Peak Power Meter via the power sensor cable.

**1-8. RECOMMENDED TEST EQUIPMENT**

Table 1-3 lists the test equipment and accessories recommended to check, adjust and repair the Peak Power Meter. If substitute equipment is used it must meet the listed critical specifications.

Table 1-3. Recommended Test Equipment (1 of 2)

Instrument Type	Critical Specifications	Suggested Model	Use*
Digital Voltmeter	0.1 mV Resolution & Accuracy 10 Volt Range	HP 3455A	A
Pulse Generator	Square wave, 0.5V P-P, 1 kHz Repetition Rate Rise time 35 ns maximum	HP 8013B	A, P
Oscilloscope	100 MHz Bandwidth	HP 1740A	A, P
Power Supply	Regulation-load effect 5 mV Source effect 3 mV Range 0—1.5V minimum Periodic and Random Deviation 200 $\mu$ V rms	HP 6203B	A
50 $\Omega$ Potentiometer	Non-wirewound 0.25W	HP 2100-0671	A
Sweep Oscillator Mainframe	0.1—18 GHz	HP 8620C	P
RF Plug-in	0.1—18 GHz	HP 86290B/C HP 86222A	P
Microwave Amplifier	Full band coverage to 18 GHz or Frequency of interest 200 mW output	HP 8349A	P
Dual Directional Coupler	20 dB attenuation on reflected and incident ports. 2—18 GHz frequency >26 dB directivity	HP 11692D	P
Power Meter	0.1—18 GHz, 1 mW to 100 mW	HP 436A	P
Power Sensor	0.1—18 GHz, 1 mW to 100 mW	HP 8481A	P
Coaxial Attenuator	10 dB attenuation 2W 100W peak	HP 8491B (Opt. 010)	P
Coaxial Step Attenuator	0.1—18 GHz 1 dB step, 11 dB total	HP 8494B	P
Power Splitter	Dc—18 GHz 0.5W input	HP 11667A	P
Power Sensor	0.1—18 GHz, 0.1 mW—3W 100W Peak	HP 8481H	P
Coaxial Crystal Detector	0.1—18 GHz 0.5 mV/ $\mu$ W minimum 200 mW input	HP 8470B	P

P = Performance; A = Adjustments; T = Troubleshooting

Table 1-3. Recommended Test Equipment (2 of 2)

Instrument Type	Critical Specifications	Suggested Model	Use*
Pulse Modulator	2–18 GHz Rise and fall time <10 ns	HP 11720A	P
System Voltmeter	0.001V resolution 1.0V full scale Settling time = 1.5 $\mu$ s Delay 0.1 $\mu$ s	HP 3437A	P
Type N Coaxial Short	Type N 50 $\Omega$	HP 11512A	P
Peak Power Sensor	No substitution	HP 84811A	P
Low Pass Filter	Cut-off frequency in GHz 2.8 4.4 6.8 9.5 13.0	HP 11688A HP 11689A HP 11684A HP 11685A HP 11686A	P
P = Performance; A = Adjustments; T = Troubleshooting			



## SECTION II INSTALLATION

### 2-1. INTRODUCTION

This section provides information about incoming inspection, selecting the input line voltage, operating environment, and information applicable to bench mounting.

### 2-2. INITIAL INSPECTION

Inspect the shipping container for damage. If the shipping container or cushioning material is damaged it should be kept until the contents of the shipment have been checked for completeness and the instrument has been checked mechanically and electrically. The contents of the shipment are shown in Figure 1-1 and the procedures for checking electrical performance are given in Section IV. If the contents are incomplete, if there is mechanical damage or defects, or if the instrument does not pass the electrical performance tests, notify the nearest Hewlett-Packard office. If the shipping container is damaged or the cushioning material shows signs of unusual stress, notify the carrier as well as the Hewlett-Packard office. Keep the shipping materials for the carrier's inspection.

### 2-3. PREPARATION FOR USE

#### 2-4. Power Requirements



Operating Voltage Range: 100/120/220/240V

Operating Frequency Range: 48-66 and 360-440Hz at  
100 and 120Vac.  
48-66Hz at 220 & 240Vac

Power Dissipation: 15 VA (max)

### 2-5. Line Voltage and Fuse Selection

Verify that the line voltage selection card and the fuse are matched to the power source. Figure 2-1 provides instructions for line voltage selection.



*Before switching on this instrument, make sure that the line voltage selector PCB board is set to the voltage of the power supply and the correct fuse installed. Figure 2-1 provides instructions for line voltage selection. Ensure the power supply voltage is in the specified range.*

*Mains supply voltage fluctuations should not exceed +5% -10% of the nominal selected line voltage.*

### WARNINGS

*Appliance coupler (mains input powercord) is the power disconnect device. Do not position the instrument such that access to the coupler is impaired.*

*For continued protection against fire hazard, replace the line fuse only with the same type and line rating (T100mA 250V @ 100V & 120V, or T62.5mA 250V @ 220V & 240V). The use of other fuses or materials is prohibited.*

*If this instrument is not used as specified, the protection provided by the equipment could be impaired. This instrument must be used in a normal condition only (in which all means for protection are intact).*

*No operator serviceable parts inside. Refer servicing to qualified personnel. To prevent electrical shock do not remove covers.*



*The rear panel of this instrument can become hot if operated at an ambient temperature greater than 50°C. Care should be taken to avoid contact.*

### 2-6. Power Cables

In accordance with international safety standards, instrument is equipped with a three-wire power cable. When connected to an appropriate ac power receptacle this cable grounds the instrument cabinet. The type of power cable shipped with each instrument depends on the country of destination. Refer to Figure 2-2 or the numbers of the power cables available.

Operating voltage is shown in module window.

### SELECTION OF OPERATING VOLTAGE

1. Open cover door, pull the FUSE PULL lever and rotate to left. Remove the fuse.
2. Remove the Line Voltage Selection Card. Position the card so the line voltage appears at top-left corner. Push the card firmly into the slot.
3. Rotate the FUSE PULL lever to its normal position. Insert a fuse of the correct value in the holder. Close the cover door.

**WARNING**

*To avoid the possibility of hazardous electrical shock, do not operate this instrument at line voltages greater than 126.5 Vac with line frequencies greater than 66 Hz (leakage currents at these line settings may exceed 3.5 mA).*

Figure 2-1. Line Voltage Selection

## 2-7. Interconnections

The Power Meter and a power sensor are integral part of this measurement system. Before measurements can be performed, the Power Meter and sensor must be connected together with the power sensor cable

## 2-8. Mating Connectors

Mating connectors used with the Peak Power Meter should be one of the following:

1. 50 ohm type BNC male
2. Five pin lock-ring male

## 2-9. Operating Environment

This instrument is designed for Indoor use only.

The instrument may be operated at temperatures for 0°C to +55°C at altitudes up to 4600m (15,000ft). The instrument may be operated in environments up to 95% relative humidity to 40°C, but it should be protected from temperature extremes which may cause condensation.



*This instrument is designed for use in Installation Category II and Pollution Degree 2 per IEC1010 and 644 respectively*

## 2-10. Operator Maintenance

- a. Use a soft clean damp cloth to clean the front-panel and side covers.
- b. Maintenance consists of changing the fuse (Refer to paragraph 3-14) and Line switch lamp replacement.

 220/240V OPERATION PLUG*: SEV 1011.1959-24507 TYPE 12 CABLE*: HP 8120-2104	 220/240V OPERATION PLUG*: NZSS 198/AS C112 CABLE*: HP 8120-1369	 100/120V OPERATION PLUG*: NEMA 5-15P CABLE*: HP 8120-1378	 220/240V OPERATION PLUG*: NEMA 6-15P CABLE*: HP 8120-0698
 220/240V OPERATION PLUG*: CEE7-VII CABLE*: HP 8120-1689	 220/240V OPERATION PLUG*: CEE22-V1 CABLE*: HP 8120-1860	 220/240V OPERATION PLUG*: BS 1363A CABLE*: HP 8120-1351	

\*The number shown for the plug is the industry identifier for the plug only.  
 \*The number shown for the cable is an HP part number for a complete cable including the plug.

Figure 2-2. Power Cables Available

**2-10. Bench Operation**

The instrument cabinet has plastic feet and foldaway tilt stands for convenience in bench operation. The plastic feet are shaped to ensure self-aligning of the instruments when stacked. The tilt stands raise the front of the instrument for easier viewing of the control panel.

**2-11. STORAGE AND SHIPMENT**

**2-12. Storage Environment**

The instrument should be stored in a clean, dry environment. The following environmental limitations apply to both storage and shipment.

- Temperature ..... 40 to +75°C
- Humidity ..... <95% relative humidity at 40°C
- Altitude ..... <7600 metres (25,000 feet)

**2-13. Packaging**

Original Packaging. Containers and materials identical to those used in factory packaging are available through Hewlett-Packard offices. If the instrument is being returned to Hewlett-Packard for servicing, attach a blue tag (found at the back of this manual), indicating the type of service required, return address, model number, and full serial number.

Also mark the container FRAGILE to assure care handling. In any correspondence, refer to the instrument by model number and full serial number.

Other Packaging. The following general instructions should be used for re-packaging with commercial available materials:

- a. Wrap the instrument in heavy paper or plastic. (If shipping to a Hewlett-Packard office or service center, attach a blue tag indicating the type of service required, return address, model number, and full serial number.)
- b. Use a strong shipping container. A double-wall carton made of 350 pound test material is adequate.
- c. Use enough shock-absorbing material (3 to 4-inch layer) around all sides of the instrument to provide a firm cushion and prevent movement inside the container. Protect the control panel with cardboard.
- d. Seal the shipping container securely.
- e. Mark the shipping container FRAGILE to assure careful handling.



## SECTION III OPERATION

### 3-1. INTRODUCTION

This section describes the functions of the controls and indicators of the Peak Power Meter. It describes how to set the front and rear panel controls, and covers such operator maintenance as fuses and indicator lamp replacement.

### 3-2. PANEL FEATURES

Front panel controls, indicators, and connectors are shown and described in Figure 3-1. Rear panel controls and connectors are shown and described in Figure 3-2.

### 3-3. OPERATING INSTRUCTIONS

Paragraph 3-17. explains how to use the Peak Power Meter.

### 3-4. POWER MEASUREMENT ACCURACY

A power measurement is never free from error or uncertainty. Any RF system has RF losses, mismatch losses, harmonics, mismatch uncertainty, instrumentation uncertainty and calibration uncertainty. Measurement errors as high as 50% are not only possible, they are highly likely unless the error sources are understood and, as much as possible, eliminated.

### 3-5. SOURCES OF ERROR AND MEASUREMENT UNCERTAINTY

#### 3-6. RF Losses

Some of the RF power that enters the power sensor is not dissipated in the power sensing elements. This RF loss is caused by dissipation in the center conductor of coaxial power sensors, in the dielectric of capacitors, in radiation losses and connections within the sensor diode caused by shunt conductance and junction capacitance.

#### 3-7. Mismatch

The result of mismatched impedance between the device under test and the power sensor is that some of the power fed to the sensor is reflected before it is dissipated in the load. Mismatches affect the measurement in two ways. First, the initial reflection is simple loss and is called mismatch loss. Second, the power reflected from the sensor mismatch travels

back up the transmission line until it reaches the source. There, most of it is dissipated in the source impedance, but some of it is re-reflected by the source mismatch. The re-reflected power returns to the power sensor and adds to, or subtracts from, the incident power. For all practical purposes, the effect the re-reflected power has upon the power measurement is unpredictable. This effect is called mismatch uncertainty.

#### 3-8. Instrumentation Uncertainty

Instrumentation uncertainty describes the ability of the metering circuits to accurately measure the dc output from the power sensor's power sensing device. In the Peak Power Meter, this error is less than  $\pm 0.35$  dB. It is important to realize, however, that a  $\pm 0.35$  dB meter does not automatically give  $\pm 0.35$  dB overall measurement accuracy.

#### 3-9. Specified Uncertainties

The specified uncertainties which account for part of the total power measurement uncertainty are:

##### a. 8900D instrumentation uncertainty

Meter Accuracy	CW	Pulse	Transfer Accuracy CW to Pulse
Direct	$\pm 0.2$ dB	$\pm 0.35$ dB	$\pm 0.2$ dB
Compare	$\pm 0.2$ dB	$\pm 0.25$ dB	$\pm 0.1$ dB

##### b. 84811A calibration uncertainty

( $+10^\circ$  to  $40^\circ\text{C}$ )  
 $\pm 0.7$  dB 0.1 GHz to 12 GHz  
 $\pm 1.0$  dB 12 GHz to 18 GHz  
 ( $0-10^\circ\text{C}$  and  $40-55^\circ\text{C}$  add  $\pm 0.2$  dB).

#### 3-10. Calculating Mismatch Uncertainty

Mismatch uncertainty is the result of the source mismatch interacting with the power sensor mismatch. The magnitude of uncertainty is related to the magnitudes of the source and power sensor reflection coefficients, which can be calculated from SWR. Paragraph 3-20 shows how the calculations are made and Figure 3-3 illustrates mismatch uncertainty and total calculated uncertainty for two cases. In the first case, the power sensor's SWR is 1.5, and in the second case, the power sensor's

**Calculating Mismatch Uncertainty (Cont'd)**

SWR is 1.25. In both cases the source has an SWR of 2.0. The example shows the effect on power measurement accuracy a poorly matched power sensor will have as compared to one with low mismatch.

A faster, easier way to find mismatch uncertainty is to use the HP Mismatch Error (uncertainty) Limits/Reflectometer Calculator. The calculator may be obtained, on request, from your nearest Hewlett-Packard office by using HP part number 5952-0948.

The method of calculating measurement uncertainty from the uncertainty in dB is shown in Paragraph 3-21. This method would be used when the initial uncertainty calculations were made with the Mismatch Error/Reflectometer Calculator.

**3-11. CORRECTIONS FOR ERROR**

**3-12. Correction Factor**

The peak power sensor used with the Peak Power Meter has an individually calibrated correction factor table printed on its cover. To correct for sensor frequency response, simply find the power sensor's correction factor at the measurement frequency from the table that is supplied with the power sensor, and set the CORRECTION switch to this value.

**3-13. Transfer Function of the Diode Current versus Input Voltage**

At low levels the output current is proportional to the square of the applied voltage. At high levels the output current is directly proportional to the input voltage. Each diode varies slightly in the precise transfer function uncertainty. The Peak Power Meter's response is shaped for the average diode. The maximum error for an HP 84811A diode transfer function is  $\pm 0.7$  dB to 12 GHz;  $\pm 1.00$  dB to 18 GHz.

Transfer uncertainty can be reduced by calibrating the meter and sensor at the frequency and power of interest.

Meter and sensor are connected to an rf source of known frequency and precise power level at CW. The CORRECTION switch is then adjusted until the Peak Power Meter displays the known power level. The meter is now calibrated to measure a pulsed signal at the CW frequency and the known power level.

The transfer uncertainty from CW to pulse is  $< 0.2$  dB for the Peak Power Meter and HP 84811A peak

power sensor. The overall CW to pulse transfer uncertainty must also include the level uncertainty of the CW calibration source, the mismatch error between the sensor and CW source and the mismatch error between the sensor and pulsed rf source.

**3-14. OPERATOR'S MAINTENANCE**



*Be sure to select the correct fuse rating for the selected line voltage (see LINE VOLTAGE SELECTION in Section II and Power Line Fuse information in Table 3-1.*

**3-15. Power Line Fuse**

The main ac line fuse is located on the rear panel next to the line power cable jack. To remove the fuse, first remove the line power cable from its jack. Slide the fuse compartment cover to the left, then pull the handle marked FUSE PULL and remove the fuse. See Table 3-1 for replacement fuse information.

**Table 3-1. Power Line Fuse Information**

Operation	Description	HP Part Number
100-120V	T0.1A, 250V	2110-0234
200-240V	T0.062A, 250V	2110-0311

**3-16. Lamp Replacement**

The lamp is contained in a plastic lens which doubles for a pushbutton on the LINE switch. When the Power Meter LINE switch is ON and is being operated by the available line power, the lamp should be illuminated. If the lamp is defective, remove the lens by pulling it straight out. Order lamp (3131-0434) (CD6) and replace the old pushbutton-lamp assembly with the new one. To replace the assembly, align the pins with the notch in the receptacle and push straight in.

**3-17. OPERATING INSTRUCTIONS**

**BEFORE SWITCHING ON THIS INSTRUMENT,** check that the power transformer primary is matched to the available line voltage, the correct fuse is installed and safety precautions are taken. See Power Requirement, Line Voltage Selection, Power Cables and associated warnings and cautions in Section II.

(ILLUSTRATIONS FOR INDICATION ONLY)

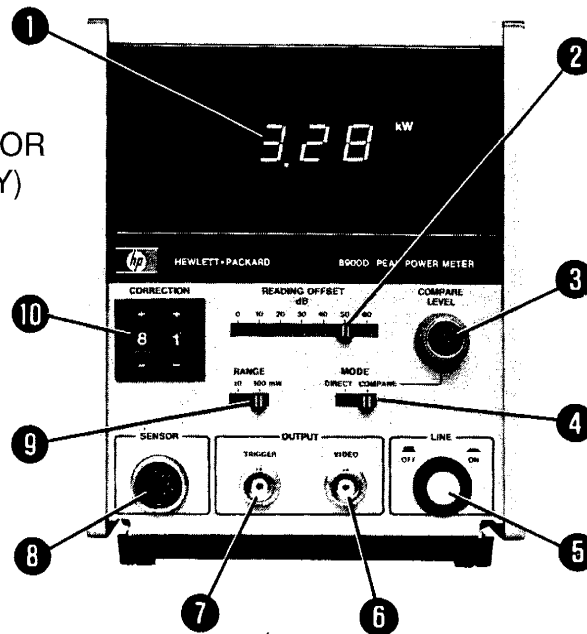

- 1 **Digital Panel Meter.** Normally indicates peak rf power in mW. Power can be displayed in watts and kilowatts when the **READING OFFSET** is used.
  - 2 **READING OFFSET dB.** The **READING OFFSET** compensates the Peak Power Meter reading for external couplers or attenuators to indicate the true power at the source. The amount of external attenuation is indicated on the slide switch.
- CAUTION**
- The **READING OFFSET** does not allow the operator to read higher power levels. The maximum power level is determined by the power sensor. For additional information refer to the power sensor manual.*
- 3 **COMPARE LEVEL.** When in compare mode the **COMPARE LEVEL** is used to measure power at user selected points on the pulse waveform. This is accomplished by adjusting the **COMPARE LEVEL** which in turn moves a reference line up or down on the pulse waveform as seen on an oscilloscope.
  - 4 **MODE switch.** Selects either **DIRECT** or **COMPARE** mode. In **DIRECT** mode the meter automatically displays the maximum rf power with no user adjustments and no external instruments. In **COMPARE** mode, the meter is disconnected from the peak detecting circuit and instead indicates power corresponding to the position of a reference line.
  - 5 **LINE switch.** Connects the line power to the Power Meter circuits when the **LINE** switch is on. The lamp contained within the **LINE** switch will be illuminated when the instrument is on. Both sides of the mains line goes through the switch.
  - 6 **VIDEO OUTPUT.** Provides detected input signal and reference line used in compare mode. Not linear with power. Nominal impedance 50Ω. BNC connector. Typical output voltage for 1 mW input is 30 mV. Dc coupled.
  - 7 **TRIGGER OUTPUT.** Provides the trigger signal for the test oscilloscope. Typical output voltage >0.1V peak. Nominal impedance 50Ω. BNC connector.
  - 8 **SENSOR Input.** Five pin lock-ring connector which serves as the input to the Power Meter from the power sensor. This connector also serves as the supply for the plus and minus five (5) volts to the sensor.
  - 9 **RANGE switch.** Sets the range of the Power Meter to either 10 mW or 100 mW maximum range.
  - 10 **CORRECTION switch.** Used to set the correction factor of the frequency where the measurement is to be taken. The correction factor data versus frequency is found on the peak power sensor.

Figure 3-1. Front Panel Controls, Indicators and Connectors

(ILLUSTRATIONS FOR INDICATION ONLY)

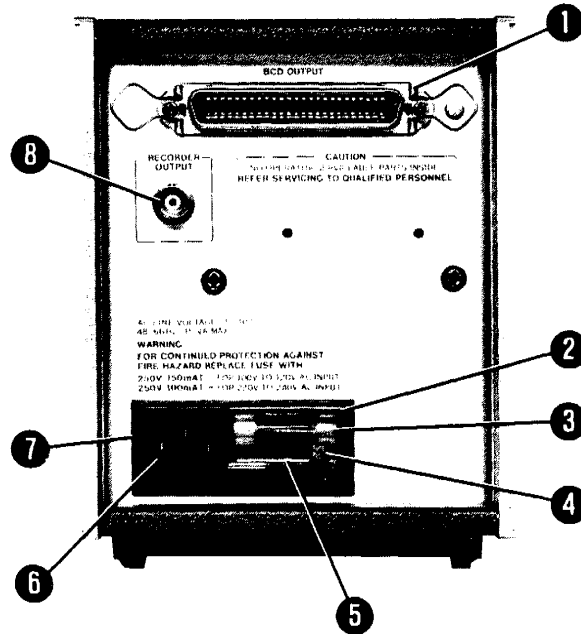

**1 BCD OUTPUT.** The front panel reading is reproduced in BCD format (Binary Coded Decimal). The BCD output is useful for remote monitoring of the meter reading. The TTL level for a 1 is typically  $>+3.5 \pm 1V$  and a 0 is typically  $<+0.2 \pm 0.4V$ .

- 2 Window.** Safety interlock; fuse cannot be removed while power cable is connected to Power Meter.
- 3 Fuse.** Refer to Table 3-1 for values.
- 4 Fuse Pull Handle.** Mechanical interlock to guarantee fuse has been removed before line voltage selection card can be removed.
- 5 Line Voltage Selection Card.** Matches transformer primary to available line voltage.
- 6 Receptacle.** For power cable connection to available line voltage.
- 7 Power Module Assembly.**
- 8 RECORDER OUTPUT.** 0—1 Vdc linearly proportional to the indicated power on each range. Output impedance 1 k $\Omega$ , BNC connector.

BCD Output at J5

Decimal	Binary			
	$10^N_D$	$10^N_C$	$10^N_B$	$10^N_A$
0	0	0	0	0
1	0	0	0	1
2	0	0	1	0
3	0	0	1	1
4	0	1	0	0
5	0	1	0	1
6	0	1	1	0
7	0	1	1	1
8	1	0	0	0
9	1	0	0	1

(Connector J5 is found on service sheet 3)

Figure 3-2. Rear Panel Features



**OPERATING INSTRUCTIONS (cont'd)****WARNING**

*BEFORE CONNECTING LINE POWER TO THE INSTRUMENT, ensure that all devices connected to this instrument are connected to the protective (earth) ground.*

*BEFORE SWITCHING ON THIS INSTRUMENT, ensure that the line power (Mains) plug is connected to a three-conductor line power outlet that has a protective (earth) ground. (Grounding one conductor of a two-conductor outlet is not sufficient.)*

**CAUTION**

*Do not twist the body of the power sensor when connecting or disconnecting it. This can cause major damage to the sensor.*

**3-18. Direct Mode**

1. Connect the power sensor to the Power Meter with the power sensor cable.
2. Connect the power cable to the power outlet and power module receptacles. Set the LINE switch to ON; the lamp within the switch lens should be lit.
3. Set the MODE switch to DIRECT.
4. Set the READING OFFSET to zero (0) dB or to the appropriate value to compensate for in-circuit attenuation.
5. Set the CORRECTION switch to the value of the correction factor found on the peak power sensor for the frequency where the measurement is to be taken.

**NOTE**

*When measuring frequencies between 100 MHz and 2 GHz, set the Correction switch to the correction factor for 2 GHz.*

6. Set the RANGE switch to 100 mW.

**NOTE**

*Set the RANGE to 10 mW when measuring 10 mW or less. A significant error will occur if the power being measured is*

*less than 10 mW and the RANGE is set to 100 mW.*

7. Connect the power sensor to an rf source. Read the power level in mW. If external coupling or attenuation is used, set the offset to the amount of in-circuit attenuation. The Power Meter will then read the power level at the source in mW, W or kW.

**CAUTION**

*See Operating Precautions in the power sensor Operating and Service Manual for maximum power levels which may be safely coupled to this system. Levels which exceed the limits may damage the power sensor, Power Meter, or both.*

**3-19. Compare Mode**

1. Perform steps 1 and 2 as stated above under DIRECT MODE.
2. Set the MODE switch to COMPARE.
3. Set the READING OFFSET to zero (0) dB or to the appropriate value to compensate for in-circuit attenuation.
4. Set the CORRECTION switch to the value of the correction factor found on the peak power sensor for the frequency where the measurement is to be taken.

**NOTE**

*When measuring frequencies between 100 MHz and 2 GHz, set the Correction switch to the correction factor for 2 GHz.*

5. Set the RANGE switch to 100 mW. If after a reading has been taken and the power level is less than 10 mW, change the RANGE to 10 mW to get better resolution.

**NOTE**

*Set the RANGE to 10 mW when measuring 10 mW or less. A significant error will occur if the power being measured is less than 10 mW and the RANGE is set to 100 mW.*

6. Connect the TRIGGER OUTPUT to the external trigger of an oscilloscope.
7. Connect the VIDEO OUTPUT to the vertical input of a dc coupled oscilloscope.

**Compare Mode (cont'd)**

8. Connect the power sensor to an rf source. Read the power level in mW. If external coupling or attenuation is used, set the offset to the amount of in-circuit attenuation. The Peak Power Meter will then read the power level at the source in mW, W or kW.
9. Adjust the scope for a clear display of the pulse waveform and the reference line.
10. It is now possible to measure power at any point on the pulse waveform. Adjust the COMPARE LEVEL to move the reference line, as seen on the scope, to the position on the pulse waveform that is of interest. The Power Meter will then display the power at that point.

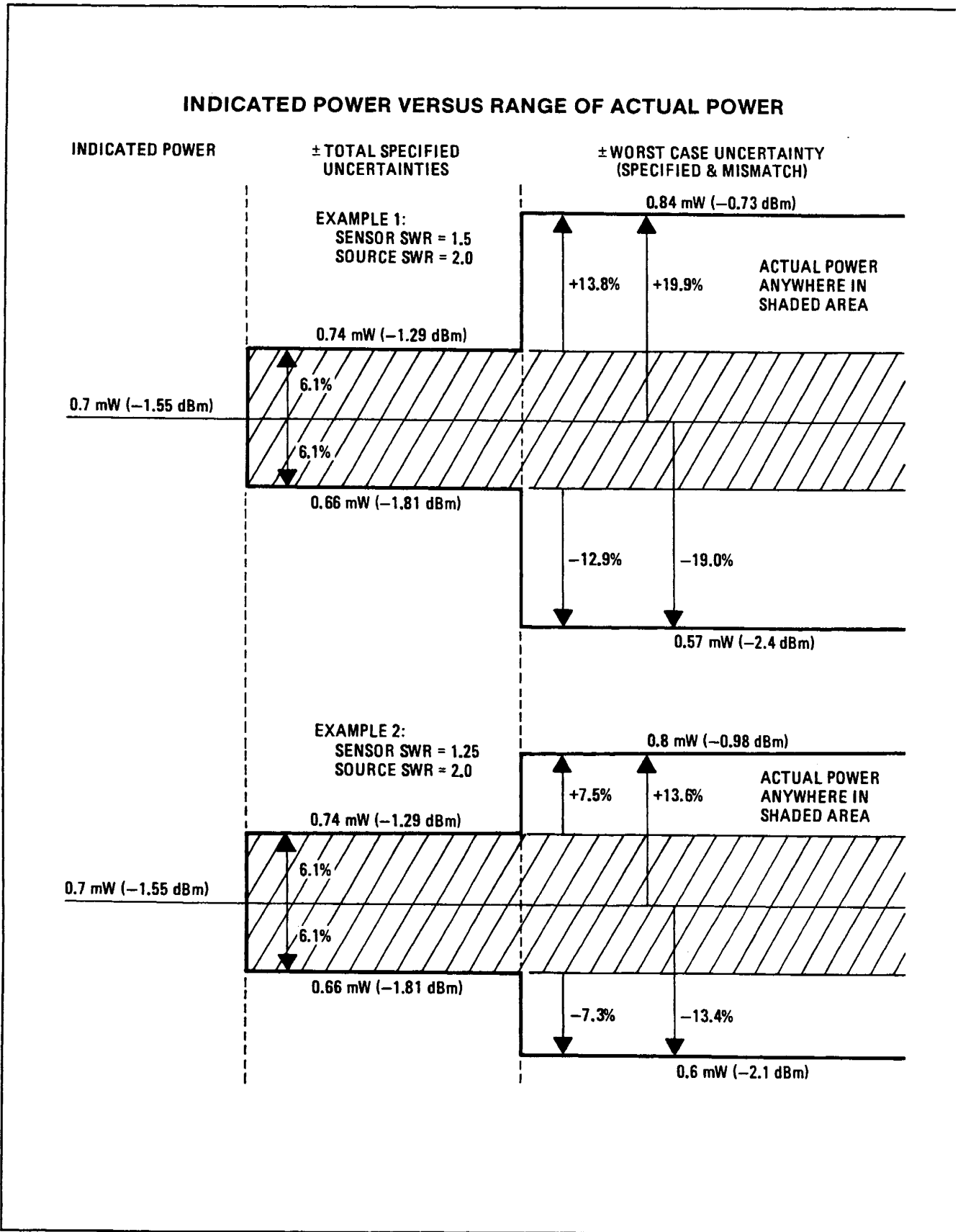

Figure 3-3. Worst Case Effects of Specified and Mismatch Uncertainties

**3-20. CALCULATING MEASUREMENT UNCERTAINTY**

1. Calculate the reflection coefficient from the given SWR.

$$\rho = \frac{\text{SWR}-1}{\text{SWR}+1}$$

Power Sensor #1  
SWR = 1.5

$$\rho_1 = \frac{1.5-1}{1.5+1}$$

$$= \frac{0.5}{2.5}$$

$$= 0.2$$

Power Sensor #2  
SWR = 1.25

$$\rho_2 = \frac{1.25-1}{1.25+1}$$

$$= \frac{0.25}{2.25}$$

$$= 0.111$$

Power Source  
SWR = 2.0

$$\rho_s = \frac{2.0-1}{2.0+1}$$

$$= \frac{1.0}{3.0}$$

$$= 0.333$$

2. Calculate the relative power and percentage power mismatch uncertainties from the reflection coefficients. An initial reference level of 1 is assumed.

*Relative Power Uncertainty*

$$\text{PU} = [1 \pm (\rho_n \rho_s)]^2$$

$$\begin{aligned} \text{PU}_1 &= \{1 \pm [(0.2)(0.333)]\}^2 \\ &= \{1 \pm 0.067\}^2 \\ &= \{1.067\}^2 \text{ and } \{0.933\}^2 \\ &= 1.138 \text{ and } 0.871 \end{aligned}$$

$$\begin{aligned} \text{PU}_2 &= \{1 \pm [(0.111)(0.333)]\}^2 \\ &= \{1 \pm 0.037\}^2 \\ &= \{1.037\}^2 \text{ and } \{0.963\}^2 \\ &= 1.075 \text{ and } 0.927 \end{aligned}$$

*Percentage Power Uncertainty*

$$\% \text{PU} = (\text{PU}-1) 100\%$$

$$\% \text{PU}_1 = (1.138-1) 100\%$$

$$= (0.138) 100\%$$

$$= 13.8\%$$

$$\% \text{PU}_2 = (1.075-1) 100\%$$

$$= (0.075) 100\%$$

$$= 7.5\%$$

$$\text{and } (0.871-1) 100\%$$

$$\text{and } (-0.129) 100\%$$

$$\text{and } -12.9\%$$

$$\text{and } (0.927-1) 100\%$$

$$\text{and } (-0.073) 100\%$$

$$\text{and } -7.3\%$$

**CALCULATING MEASUREMENT UNCERTAINTY (cont'd)**

3. Calculate the Measurement Uncertainty in dB.

$$\text{MU} = 10 \left[ \log_{10} \left( \frac{P_1}{P_0} \right) \right] \text{ dB}$$

$$\text{MU}_1 = 10 \left[ \log \left( \frac{1.138}{1} \right) \right] \quad \text{and} \quad 10 \left[ \log \left( \frac{0.871}{1} \right) \right]$$

$$= 10 [0.056] \quad \text{and} \quad 10 [-0.060]$$

$$= +0.56 \text{ dB} \quad \text{and} \quad -0.60 \text{ dB}$$

$$\text{MU}_2 = 10 \left[ \log \left( \frac{1.075}{1} \right) \right] \quad \text{and} \quad 10 \left[ \log \left( \frac{0.927}{1} \right) \right]$$

$$= 10 [0.031] \quad \text{and} \quad 10 [-0.033]$$

$$= +0.31 \text{ dB} \quad \text{and} \quad -0.33 \text{ dB}$$

**3-21. CALCULATING MEASUREMENT UNCERTAINTY WHEN UNCERTAINTY IN dB IS KNOWN**

1. For this example the known values are: source SWR, 2.2 and power sensor SWR, 1.16. From the Mismatch Error Calculator the mismatch uncertainty is found to be +0.24, -0.25 dB.
2. Add the specified uncertainties from Figure 3-5, ( $\pm 0.26$  dB). Our total measurement uncertainty is +0.50, -0.51 dB.
3. Calculate the relative measurement uncertainty from the following formula:

$$\text{dB} = 10 \log\left(\frac{P_1}{P_0}\right)$$

$$\frac{\text{dB}}{10} = \log\left(\frac{P_1}{P_0}\right)$$

$$\frac{P_1}{P_0} = \log^{-1}\left(\frac{\text{dB}}{10}\right)$$

$$\begin{aligned} \text{MU} = P_1 &= \log^{-1}\left(\frac{\text{dB}}{10}\right) \\ &= \log^{-1}\left(\frac{0.50}{10}\right) &= \log^{-1}\left(\frac{-0.51}{10}\right) \\ &= 1.122 &= 0.889 \end{aligned}$$

4. Calculate the percentage Measurement Uncertainty.

$$\begin{aligned} \% \text{MU} &= (P_1 - P_0) 100 \\ &= (1.122 - 1) 100 &= (0.889 - 1) 100 \\ &= +12.2\% &= -11.1\% \end{aligned}$$

## SECTION IV PERFORMANCE TESTS

### WARNINGS

*Any interruption of the protective (grounding) conductor (inside or outside the instrument) or disconnecting the protective earth terminal will cause a potential shock hazard that could result in personal injury. (Grounding one conductor of a two conductor outlet is not sufficient protection). In addition, verify that a common ground exists between the unit under test and this instrument prior to energizing either unit.*

*Whenever it is likely that the protection has been impaired, the instrument must be made inoperative and be secured against any unintended operation.*

*If this instrument is to be energized via an auto-transformer (for voltage reduction), make sure the common terminal is connected to neutral (that is, the grounded side of the mains supply).*

*Servicing instructions are for use by service-trained personnel only. To avoid dangerous electric shock, do not perform any servicing unless qualified to do so.*

*For continued protection against fire hazard, replace the line fuse(s) only with 250V fuse(s) of the same current rating and type (for example, normal blow, time delay, etc.). Do not use repaired fuses or short circuited fuseholders.*

### 4-1. INTRODUCTION

The procedures in this section test the electrical performance of the Peak Power Meter using the specifications of Table 1-1 as performance standards. All tests can be performed without access to the interior of the instrument. A simpler operational test is included in Section III under Operator's Checks.

### 4-2. EQUIPMENT REQUIRED

Equipment required for the performance tests is listed in Table 1-3, Recommended Test Equipment. Any equipment that satisfies the critical specifications given in the table may be substituted for the recommended model(s).

### 4-3. TEST RECORD

Results of the performance tests may be tabulated on the Test Record at the end of the test procedures. The Test Record lists all of the tested specifications and their acceptable limits. Test results recorded at incoming inspection can be used for comparison in periodic maintenance, troubleshooting and after repairs or adjustments.

### 4-4. PERFORMANCE TESTS

The performance tests given in this section are suitable for incoming inspection, troubleshooting or preventive maintenance. During any performance test, all shields and connecting hardware must be in place. Perform the tests in the order given and record the data on the test card and/or in the data spaces provided at the end of each procedure.

#### NOTE

*The Peak Power Meter must have a half-hour warmup and the line voltage must be within +5%, -10% of nominal if the performance tests are to be considered valid.*

Each test is arranged so that the specification is written as it appears in Table 1-1. Next, a description of the test and any special instructions or problem areas are included. Each test that requires test equipment has a setup drawing and a list of the required equipment. The initial steps of each procedure give control settings required for that particular test.

**PERFORMANCE TESTS**

**4-5. PEAK POWER SENSOR PERFORMANCE TEST (Return Loss)**

**SPECIFICATION** SWR: 100 MHz to 12 GHz < 1.5  
 12 GHz to 18 GHz < 2.0

**DESCRIPTION** To verify SWR specifications a Return Loss Test is performed. The Return Loss Test may be run without the Peak Power Sensor being connected to the Peak Power Meter. A microwave source is connected by appropriate attenuation to a dual directional coupler. The Peak Power Sensor is connected to the test port of the directional coupler. The incident and reflected ports of the directional coupler are connected to power meters. From the power measurements made on the incident and reflected ports, Return Loss can be calculated.

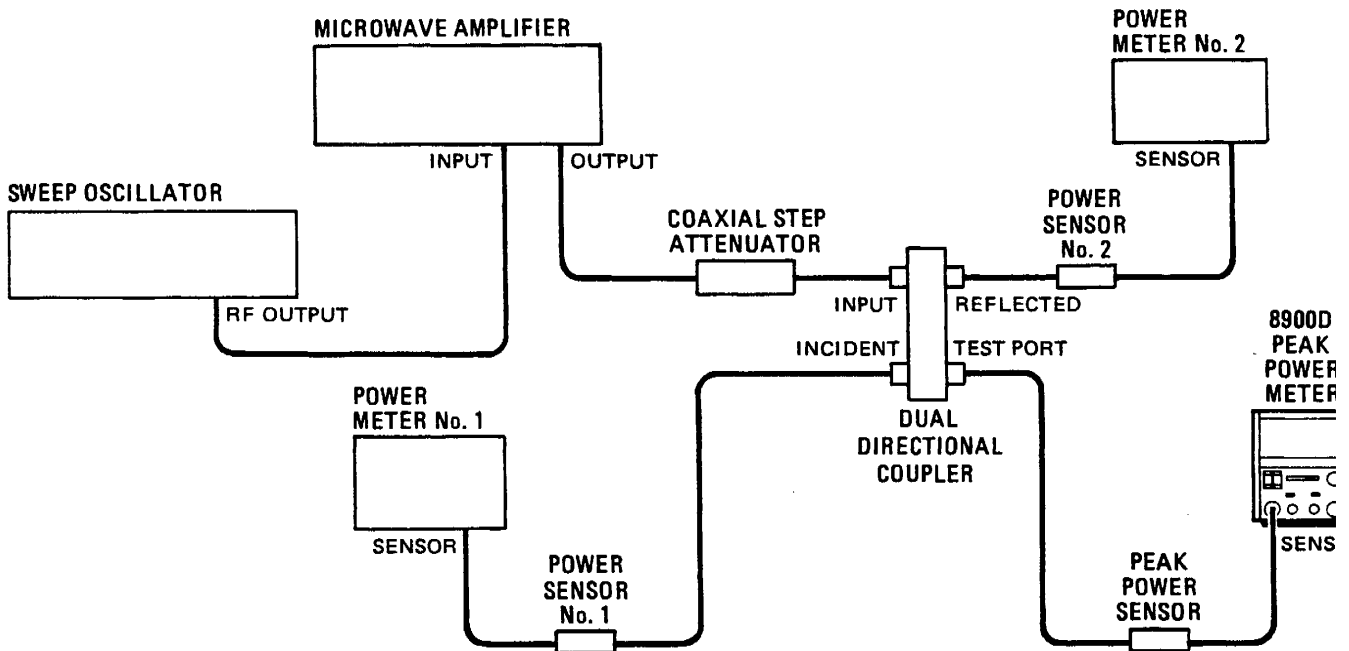

**Figure 4-1. Peak Power Sensor Performance Test (Return Loss)**

<b>EQUIPMENT</b>	Sweep Oscillator Mainframe .....	HP 8620C
	RF Plug-in .....	HP 86290B/C and HP 86222A
	Microwave Amplifier .....	HP 8349A
	Coaxial Step Attenuator (1 dB/step) .....	HP 8494B
	Dual Directional Coupler .....	HP 11692D
	Power Meter (2 required) .....	HP 436A
	Power Sensor (2 required) .....	HP 8481A
	Coaxial Attenuator (10 dB) .....	HP 8491B Opt. 010
	Type N Coaxial Short .....	HP 11512A
	Type N Coaxial Open (made from the following parts): .....	HP 1250-0196 Body, HP 1250-0016 Snap Ring, HP 1250-0198 Nut



---

**PERFORMANCE TESTS**

---

**4.5 PEAK POWER SENSOR PERFORMANCE TEST (Return Loss) (cont'd)****NOTES**

*Use the appropriate microwave amplifier depending on the frequency of interest.*

*The type N coaxial open is required only for measurements above 10 GHz.*

**PROCEDURE:**

1. Set the coaxial step attenuator to 11 dB of attenuation. Connect the equipment as shown in Figure 4-1. Allow at least one half hour for the equipment to warm up. Then before doing the performance test, be sure the test port output of the coupler is less than 100 mW.
2. Set the sweep oscillator to CW, and set to the frequency of interest. Make sure that the microwave amplifier is compatible with the frequency of the sweep oscillator.

Frequency of interest \_\_\_\_\_

3. Using the 10 dB coaxial attenuator connected to the test port of the dual directional coupler, measure the power output with power meter #2. Adjust the sweep oscillator and/or the microwave amplifier for +10 dBm at the attenuator output. Read and record the power level of power meter #1. This value is the incident wave reference level. Remove the attenuator and connect power meter #2 to the reflected port of the dual directional coupler.

Power Meter #1 (Incident Wave Reference Level) \_\_\_\_\_

4. Terminate the test port of the dual directional coupler with a type N open constructed from the parts listed in the equipment list. It is not necessary to use this non-radiating open if operating below 10 GHz. Readjust the source so that the reading on power meter #1 is equal to the incident wave reference level measured in step #3. Measure and record the power level using power meter #2, at the reflected port.

Power Meter #2 (reflected port) \_\_\_\_\_

5. Terminate the test port with a type N coaxial short. Readjust the source so that the reading on power meter #1 is equal to the incident wave reference level measured in step #3. Measure and record the power level at the reflected port as in the previous step.

Power Meter #2 (reflected port) \_\_\_\_\_

6. Compute the average power measured on power meter #2 in steps 4 and 5 above. This value is the return loss reference.

Return loss reference \_\_\_\_\_

7. Connect the Peak Power Sensor and Peak Power Meter to the test port. Using power meter #1, monitor the power level at the incident port and adjust to the same level as in step 3 if necessary.

8. Read and record the power level indicated on power meter #2.

Power Meter #2 \_\_\_\_\_

---

---

**PERFORMANCE TESTS**

---

**4-5. PEAK POWER SENSOR PERFORMANCE TEST (Return Loss) (cont'd)**

9. Determine and record the maximum error of the test system using the following data:

Test Frequency	Error
100 MHz to 8 GHz	1.5 dB
8 GHz to 12 GHz	2.1 dB
12 GHz to 18 GHz	1.4 dB

Error \_\_\_\_\_ d

10. Compute the return loss for D.U.T. using the following formula.

$$\begin{aligned}
 & \text{(Power Meter \#2 reading — step 8) } \underline{\hspace{2cm}} \\
 & - \text{(Return Loss Reference — step 6) } \underline{\hspace{2cm}} \\
 & + \text{(Maximum Error of test system — Step 9) } \underline{\hspace{2cm}}
 \end{aligned}$$

Return Loss of D.U.T. \_\_\_\_\_

For frequencies between 100 MHz and 12 GHz return loss for D.U.T. must be > 14 d (or < 1.5 SWR).

For frequencies between 12 GHz and 18 GHz the return loss for D.U.T. must be > 9.55 d (or < 2.0 SWR).

**PERFORMANCE TESTS**

**4-6. PEAK POWER MEASUREMENT SYSTEM PERFORMANCE TESTS**

**SPECIFICATIONS:** Meter accuracy, CW:  $\pm 0.2$  dB

**Sensor accuracy:**  $\pm 0.7$  dB 0.1 to 12 GHz  
 $\pm 1.0$  dB 12 GHz to 18 GHz

**Rise time:** 75 ns

**Fall time:** 125 ns

**Pulse response**

**Pulse width:** 1  $\mu$ s to CW

**Repetition rate:** 100 Hz to 100 kHz

**Transfer accuracy**

**CW to Pulse:**  $\pm 0.2$  dB

**DESCRIPTION:** The Peak Power Meter is tested for accuracy using a CW microwave signal and comparing the result against the power measured by a known calibrated power meter.

Pulsed rf accuracy is measured by monitoring the value of the detected voltage of a high duty cycle signal, and measuring the peak power. The duty cycle is then reduced to a very low value. Next, readjusting the power level to obtain the same value of detected voltage assures that the peak power level is the same as with the high duty cycle. The power level is then read on the Peak Power Meter and compared with the reading obtained on the high duty cycle pulse.

Rise and fall times of the detected pulse are checked by monitoring these parameters with an oscilloscope.

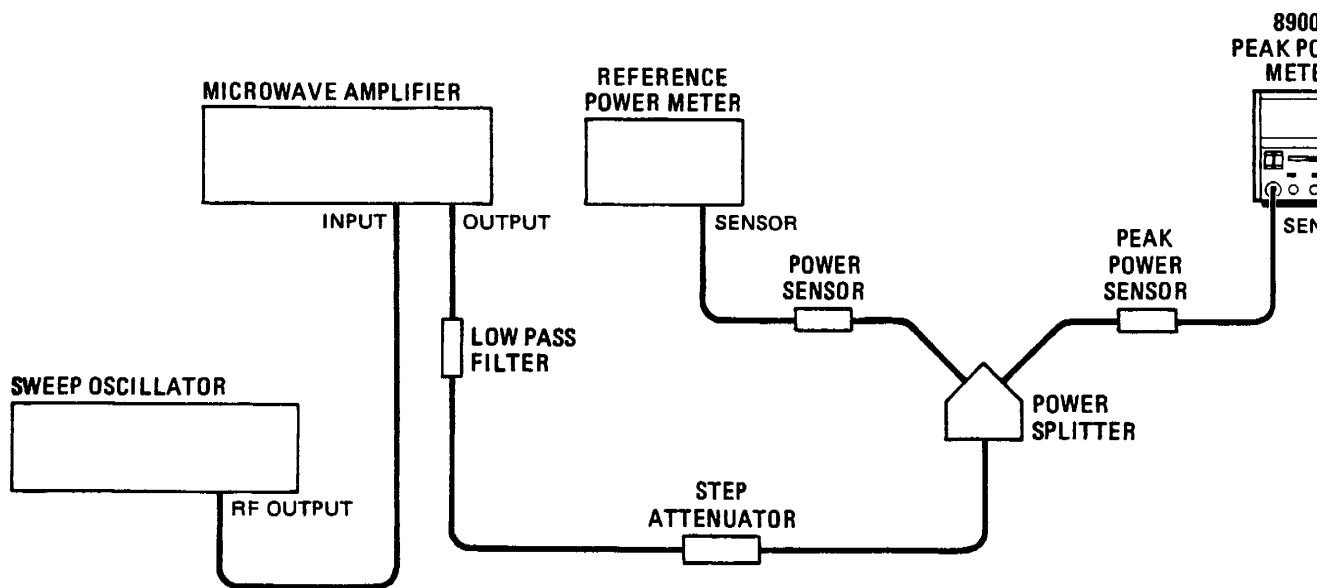

**Figure 4-2. CW Power Measurement Accuracy**

---

**PERFORMANCE TESTS**

---

**4-6. PEAK POWER MEASUREMENT SYSTEM PERFORMANCE TESTS (cont'd)**

<b>EQUIPMENT:</b>	Sweep Oscillator Mainframe .....	HP 8620C
	RF Plug-in .....	HP 86290A
	Microwave Amplifier .....	HP 86290B/C, HP 86222A
	Coaxial Step Attenuator (1 dB/step) .....	HP 8349A
	Power Splitter .....	HP 11667A
	Power Meter .....	HP 436A
	Power Sensor .....	HP 8481H
	Coaxial Attenuator (10 dB) .....	HP 8491B Opt. 010
	Coaxial Crystal Detector .....	HP 8470B
	Pulse Generator .....	HP 8013B
	Pulse Modulator .....	HP 11720A
	Oscilloscope .....	HP 1740A
	System Voltmeter .....	HP 3437A
	Peak Power Sensor .....	HP 84811A
	Low Pass Filter .....	HP 11688A, 11689A, 11684A, 11685A, 11686A

**NOTE**

*Use the appropriate microwave amplifier(s) depending on the frequency of interest.*

**PROCEDURE: CW POWER ACCURACY, DIRECT MODE**

1. Set up the equipment as shown in figure 4-2.
2. Set the CORRECTION switch on the Peak Power Meter to the value specified on the peak power sensor for the frequency of interest.
3. Set the Peak Power Meter to the 10 mW RANGE.
4. Set the attenuator to maximum attenuation (11 dB).
5. Turn on all equipment and allow at least one half hour warmup period.
6. Calibrate the reference power meter, and set it to read in dBm.
7. Adjust the signal source power output for a reading of 1 mW on the Peak Power Meter. Read the reference power meter. Repeat the above measurement at 5, 10, 50, and 100 mW. Adjust the RANGE of the Peak Power Meter so that the display does not overrange for each power setting. The power meter should read as follows:

The meter accuracy at CW is  $\pm 0.2$  dB.

The sensor has an accuracy of  $\pm 0.7$  dB, 0.1 to 12 GHz, and  $\pm 1.0$  dB, 12 GHz to 18 GHz. By adding the two accuracy specifications the test specification is arrived at.

**PERFORMANCE TESTS**

**4-6. PEAK POWER MEASUREMENT SYSTEM PERFORMANCE TESTS (cont'd)**

Frequency	Peak Power Meter Reading	Reference Power Meter Reading	Test Specifications
0.1–12 GHz	1 mW	_____	0 dBm ±0.9 dB
	5 mW	_____	7 dBm ±0.9 dB
	10 mW	_____	10 dBm ±0.9 dB
	50 mW	_____	17 dBm ±0.9 dB
	100 mW	_____	20 dBm ±0.9 dB
12 to 18 GHz	1 mW	_____	0 dBm ±1.2 dB
	5 mW	_____	7 dBm ±1.2 dB
	10 mW	_____	10 dBm ±1.2 dB
	50 mW	_____	17 dBm ±1.2 dB
	100 mW	_____	20 dBm ±1.2 dB

**CW POWER ACCURACY, COMPARE MODE**

1. Keeping the same test setup as above, connect the VIDEO output from the Peak Power Meter to the oscilloscope's A channel. Set the oscilloscope to 10 ms/div and 0.05 volts/div. Set the signal level for a full scale reading on the Peak Power Meter of 10 mW. Set the Peak Power Meter to COMPARE mode. Adjust the COMPARE LEVEL control so the two lines shown on the oscilloscope converge to form one line. The display on the Peak Power Meter should be within +4.7% or -4.5% of the reading in DIRECT mode.

Reading Direct	Reading Compare	Specification
10 mW	_____	+9.55 to +10.47 mW

2. Repeat the procedure using 100 mW.

Reading Direct	Reading Compare	Specification
100 mW	_____	+95.5 to +104.7 mW

**PERFORMANCE TESTS**

**4-6. PEAK POWER MEASUREMENT SYSTEM PERFORMANCE TESTS (cont'd)**

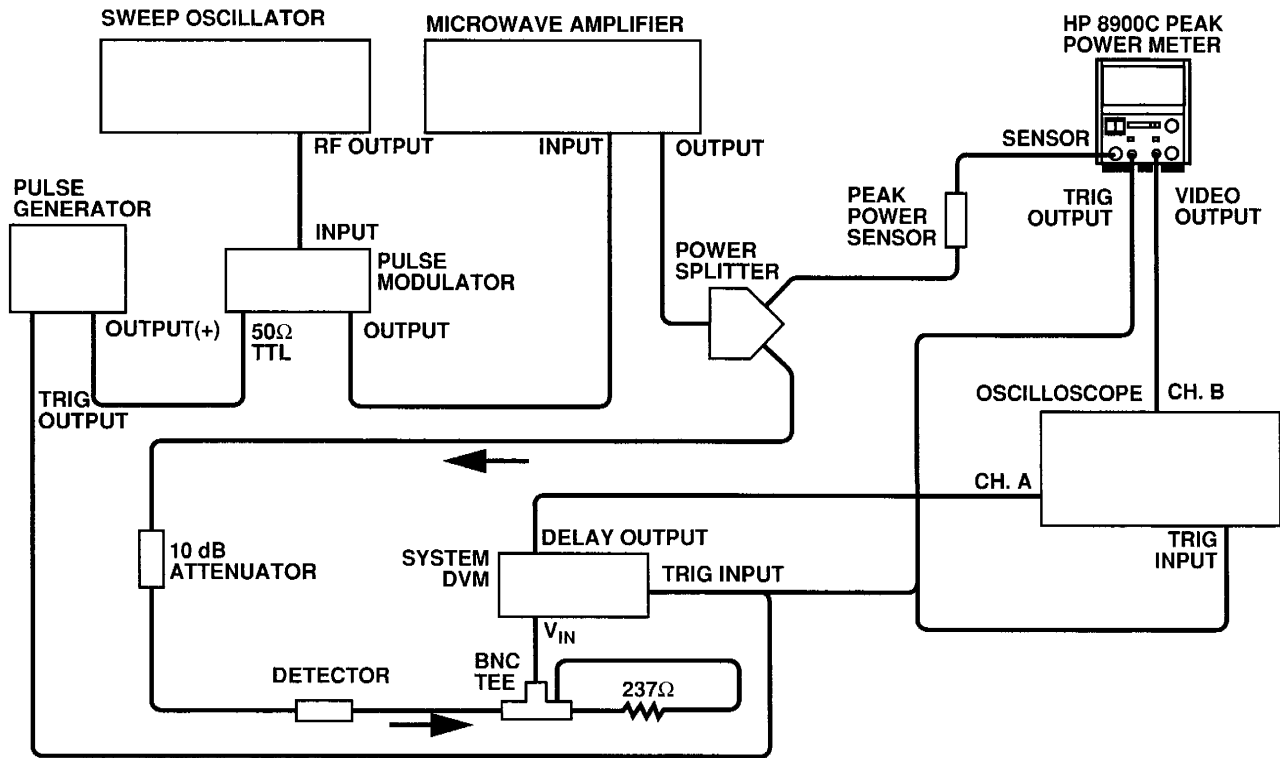

Figure 4-3. Peak Power Measurement Accuracy

**VIDEO PULSE RISE/FALL TIME**

1. Reconfigure the test setup as in Figure 4-3. Set the step attenuator to maximum attenuation. Set the pulse generator for 10  $\mu$ s pulsewidth, and 1 kHz repetition rate. Set the Peak Power Meter to DIRECT mode. Adjust the frequency slightly to obtain the sharpest looking square wave on the oscilloscope. This adjustment will compensate for mismatch and standing waves.

2. Measure the rise and fall times of the video output pulse between the 10 and 90% points. The rise time should be less than 75 ns, and the fall time should be less than 125 ns.

Rise \_\_\_\_\_ < 75 ns

Fall \_\_\_\_\_ < 125 ns

**PULSE POWER ACCURACY**

1. Reconfigure the test setup as shown in Figure 4-3. Adjust the pulse generator for a +5 volt pk output, 100 Hz repetition rate and 1  $\mu$ s pulse width. Adjust the sweep oscillator for 6 GHz, or the frequency of interest. Adjust the signal source for an indicated power level of 100 mW on the Peak Power Meter. Set the oscilloscope to 10 ms/div, channel A (video out) to 0.5 V/div and channel B (delay out) to 5 V/div. Set the oscilloscope's trigger to external and positive, and set the display mode to chop. The pulse modulator should be set to normal, 50 $\Omega$  TTL. Set the system voltmeter to external trigger, 1 volt range and delay equal to 0.000002 seconds. Adjust the sweep oscillator frequency slightly to obtain the squarest pulse with no overshoot.

**PERFORMANCE TESTS**

---

**4-6. PEAK POWER MEASUREMENT SYSTEM PERFORMANCE TESTS (cont'd)**

2. Reset the pulse generator for approximately 9.5 ms pulse width. This corresponds to 95% duty cycle (95% is an approximation of CW). Readjust the signal source output level for a displayed power of 100 mW on the Peak Power Meter.

3. Vary the delay of the pulse generator while monitoring the system voltmeter. Note and record the peak negative value.

Peak Negative Value \_\_\_\_\_

4. Change the oscilloscope sweep speed to 0.5  $\mu$ s/div. Reduce pulse generator delay to minimum, and set the pulse width to 1  $\mu$ s wide at the 90% points on the detected waveform.

5. Vary the delay of the pulse generator while monitoring the system voltmeter, and set to peak negative value. Adjust the signal source output so that the reading of the system voltmeter is equal to that of step 3. Note the reading of the Peak Power Meter. The difference between this reading and the value set in step 2 should be within +4.7%, -4.5%, that is  $\pm 0.2$  dB.

**Specification**

(Step 2 \_\_\_\_\_) - (Step 5 \_\_\_\_\_) = \_\_\_\_\_ +95.5 to +104.7 mW

6. Reset the power level to 10 mW. Remove the 10 dB attenuator from between the power splitter and the coaxial detector. Repeat steps 2 through 5 using the new power level. The same specifications apply.

Peak Negative Value \_\_\_\_\_

**Specification**

(Step 2 \_\_\_\_\_) - (Step 5 \_\_\_\_\_) = \_\_\_\_\_ +9.55 to +10.47 mW

7. Insert the 10 dB attenuator between the peak power sensor and the power splitter. This reduces the power to the peak power sensor to 1 mW. Repeat steps 2 through 5 using the 1 mW power level. The same specifications apply.

Peak Negative Value \_\_\_\_\_

**Specification**

(Step 2 \_\_\_\_\_) - (Step 5 \_\_\_\_\_) = \_\_\_\_\_ +.955 to +1.047 mW

Table 4-1. Performance Test Record (1 of 2)

Hewlett-Packard Company Model 8900D Peak Power Meter Serial Number _____		Tested By _____ Date _____		
Para No.	Test Description	Results		
		Min	Actual	Max
4-5.	<b>PEAK POWER SENSOR PERFORMANCE TEST (Return Loss)</b>			
	<b>Step 2</b> Frequency of interest _____			
	<b>Step 3</b> Power Meter #1 _____ (Incident Wave Reference Level)			
	<b>Step 4</b> Power Meter #2 _____ (Reflected port)			
	<b>Step 5</b> Power Meter #2 _____ (Reflected port)			
	<b>Step 6</b> Return Loss Reference _____			
	<b>Step 8</b> Power Meter #2 _____			
	<b>Step 9</b> Error _____ dB			
	<b>Step 10</b> Return Loss of D.U.T.	14 dB (100 MHz to 12 GHz)	_____	
		9.55 dB (12 GHz to 18 GHz)	_____	



Table 4-1. Performance Test Record (2 of 2)

Sect. No.	Test Description	Results				
		Min	Actual	Max		
4-6.	<b>PEAK POWER MEASUREMENT SYSTEM PERFORMANCE TESTS</b>					
	<b>CW Power Accuracy, Direct Mode</b>					
		<b>Frequency</b>	<b>Peak Power Meter Reading</b>			
		0.1 to 12 GHz	1 mW	-0.9 dBm	_____ dBm	+0.9 dBm
			5 mW	+6.1 dBm	_____ dBm	+7.9 dBm
			10 mW	+9.1 dBm	_____ dBm	+10.9 dBm
			50 mW	+16.1 dBm	_____ dBm	+17.9 dBm
			100 mW	+19.1 dBm	_____ dBm	+20.9 dBm
		12 GHz to 18 GHz	1 mW	-1.2 dBm	_____ dBm	+1.2 dBm
			5 mW	+5.8 dBm	_____ dBm	+8.2 dBm
			10 mW	+8.8 dBm	_____ dBm	+11.2 dBm
			50 mW	+15.8 dBm	_____ dBm	+18.2 dBm
			100 mW	+18.8 dBm	_____ dBm	+21.2 dBm
		<b>CW Power Accuracy, Compare Mode</b>				
		<b>Step 1</b>	<b>Reading, Direct</b>			
			10 mW	+9.55 mW	_____ mW	+10.47 mW
		<b>Step 2</b>	<b>Reading, Direct</b>			
			100 mW	+95.5 mW	_____ mW	+104.7 mW
		<b>Video Pulse Rise/Fall Time</b>				
		<b>Step 2</b>	<b>Rise time</b>			
					_____ ns	75 ns
			<b>Fall time</b>			
					_____ ns	125 ns
		<b>Pulse Power Accuracy</b>				
	<b>100 mW</b>					
	<b>Step 3</b>	<b>Peak Negative Value</b> _____				
	<b>Step 5</b>	<b>(Step 2 _____) - (Step 5 _____) =</b>	+95.5 mW	_____ mW	+104.7 mW	
	<b>10 mW</b>					
	<b>Step 6</b>	<b>Peak Negative Value</b> _____				
		<b>(Step 2 _____) - (Step 5 _____) =</b>	+9.55 mW	_____ mW	+10.47 mW	
	<b>1 mW</b>					
	<b>Step 7</b>	<b>Peak Negative Value</b> _____				
		<b>(Step 2 _____) - (Step 5 _____) =</b>	+0.955 mW	_____ mW	+1.047 mW	



## SECTION V ADJUSTMENTS

### WARNINGS

*Any interruption of the protective (grounding) conductor (inside or outside the instrument) or disconnecting the protective earth terminal will cause a potential shock hazard that could result in personal injury. (Grounding one conductor of a two conductor outlet is not sufficient protection). In addition, verify that a common ground exists between the unit under test and this instrument prior to energizing either unit.*

*Whenever it is likely that the protection has been impaired, the instrument must be made inoperative and be secured against any unintended operation.*

*If this instrument is to be energized via an auto-transformer (for voltage reduction), make sure the common terminal is connected to neutral (that is, the grounded side of the mains supply).*

*Servicing instructions are for use by service-trained personnel only. To avoid dangerous electric shock, do not perform any servicing unless qualified to do so.*

*Adjustments described in the manual are performed with power supplied to the instrument while protective covers are removed. Energy available at many points may, if contacted, result in personal injury.*

*Capacitors inside the instrument may still be charged even if the instrument has been disconnected from its source of supply.*

*For continued protection against fire hazard, replace the line fuse(s) only with 250V fuse(s) of the same current rating and type (for example, normal blow, time delay, etc.). Do not use repaired fuses or short circuited fuseholders.*

### 5-1. INTRODUCTION

This section describes the adjustments which will return the Peak Power Meter to peak operating condition. The adjustments are to be performed whenever performance test results are out of tolerance. This may occur over a period of time because of aging of components within the instrument or because of repair or replacement of certain components, parts or assemblies. Information is provided in this section about the equipment required to perform the tests.

An adjustment procedure includes reference to service sheets where the adjustable components are shown, a description of the test including any problem areas or special instructions, a test equipment setup diagram (if necessary), test equipment recommended for the test, and a step-by-step procedure for performing the adjustments. Removal and installation procedures are presented in Section 8. Adjustment locations are shown in photographs on Service Sheets 1, 2 and 3.

The following general information applies to all adjustments unless otherwise indicated.

- a. Half hour warm-up period is required.
- b. Prior to any adjustment, check power supply voltages as indicated on the troubleshooting block diagram.

### 5-2. EQUIPMENT REQUIRED

The test equipment required for the adjustment procedures is listed in Table 1-3, Recommended Test Equipment. The critical specifications of substitute test instruments must meet or exceed the standards listed in the table if the performance of the Peak Power Meter is to meet the standards set forth in Table 1-1, Specifications.

## ADJUSTMENTS

---

### 5-3. PEAK POWER METER ADJUSTMENTS

<b>Reference</b>	Service Sheets 1, 2 and 3.
<b>Description</b>	The power supply voltages are set first because they affect all other adjustments. The Zero Offset, 8X Offset and Video Offset adjustments are set next. These adjustments are all accomplished by monitoring the appropriate test point with a digital voltmeter and adjusting the corresponding potentiometer. The Digital Panel Meter adjustment is made by comparing the displayed Peak Power Meter reading with the value shown on the digital voltmeter. The Gain adjustment is made by supplying a known input and adjusting the 8X G potentiometer for the proper voltage.
<b>Equipment</b>	Digital Voltmeter ..... HP 3455A Pulse Generator ..... HP 8013B Oscilloscope ..... HP 1740A DC Power Supply ..... HP 6203B 50 Ohm Variable Resistor ..... HP 2100-0671
<b>Procedure</b>	<p><b>POWER SUPPLY ADJUSTMENTS</b></p> <ol style="list-style-type: none"> <li>1. Turn all equipment on and allow at least one half hour warmup period. Remove top and side covers from the Peak Power Meter.</li> <li>2. Connect the digital voltmeter between the GND and -5.4V testpoint on the A3 motherboard assembly. Check for a reading of <math>-5.40 \pm 0.01</math> Vdc. If necessary, adjust the -5.4V potentiometer on the A3 assembly to obtain this value.</li> <li>3. Connect the digital voltmeter probe to the +5.2V testpoint on the A3 motherboard assembly. Check for a reading of <math>+5.20 \pm 0.01</math> Vdc. If necessary, adjust the +5.2V potentiometer on the A3 assembly to obtain this value. Do not adjust either power supply if the voltage is within limits as this will affect all other adjustments.</li> </ol> <p><b>OFFSET ADJUSTMENTS</b></p> <ol style="list-style-type: none"> <li>1. On the Peak Power Meter, set the CORRECTION control to 50, the MODE switch to DIRECT, and the RANGE switch to 100 mW. Connect a jumper wire between the terminal with the green wire on the CORRECTION control and chassis ground.</li> <li>2. Connect the digital voltmeter probe to PK DET, testpoint A3TP10. Adjust OFS, on the A3 assembly, for a voltmeter reading of <math>0.0000 \pm 0.0001</math> Vdc.</li> <li>3. Connect the digital voltmeter probe to 8X OUT, testpoint A3TP11. Adjust 8X OFS, on the A3 assembly, for a voltmeter reading of <math>0.0000 \pm 0.0005</math> Vdc.</li> <li>4. Connect the digital voltmeter to the VIDEO OUTPUT on the front panel. Adjust V OFS, on the A3 assembly, for a voltmeter reading of <math>0.0000 \pm 0.0005</math> Vdc. Disconnect the jumper wire between the CORRECTION control and chassis ground.</li> </ol> <p><b>CORRECTION CONTROL ADJUSTMENT</b></p> <ol style="list-style-type: none"> <li>1. Connect a 50 ohm potentiometer in series with the negative output of the dc power supply. Adjust the dc power supply and the variable resistor for an output of <math>-0.5562 \pm 0.0005</math> Vdc when applied to the terminal with the green wire on the CORRECTION control.</li> </ol>

---

**ADJUSTMENTS**

---

**5-3. PEAK POWER METER ADJUSTMENTS (cont'd)**

2. Set the CORRECTION control to 50. Connect the digital voltmeter to PI, A3TP7. The voltmeter should read  $-0.4164 \pm 0.0047$  Vdc. Set the CORRECTION control to 0. The voltmeter should now read between  $-0.2747$  and  $-0.2840$  Vdc. Since the instrument is more often used with the CORRECTION set to between 20 and 80 than to zero, it is preferable to have the adjustment at 50 be closer to nominal value than at zero. Adjust COR, on the A1 assembly, with the CORRECTION control set to 50, for the optimum value of  $-0.4164$  Vdc. Check to be sure that the limits at zero are still being met.

**GAIN AND OFFSET ADJUSTMENTS**

1. With the CORRECTION control set to 50 and  $-.5562$  volts applied to the green wire on the CORRECTION control, connect the digital voltmeter to 8X OUT, A3TP11. Adjust 8X G, on the A3 assembly, for a voltmeter reading of  $3.000 \pm 0.002$  Vdc.

2. Set the MODE switch to DIRECT, the CORRECTION control to 50, and the RANGE switch to 100 mW. Connect the digital voltmeter to the rear panel RECORDER OUTPUT. Adjust the dc power supply so that the voltmeter reads  $1.000 \pm 0.001$  Vdc. Set the Meter Adjust potentiometer, on the M1A2 assembly, so that the Peak Power Meter display reads 100 mW.

3. Set the dc power supply output to  $-0.0357 \pm 0.0002$  Vdc. Set the RANGE to 10 mW. Adjust the 10 OFS, on the A2 assembly, for a display of  $1.00 \pm 0.01$  mW on the Peak Power Meter.

4. Set the dc power supply output to  $-0.1605 \pm 0.0002$  Vdc. Set the Peak Power Meter to 10 mW RANGE. Adjust the 10 mW GAIN, on the A2 assembly, for a Peak Power Meter display of  $10.00 \pm 0.01$  mW. Repeat steps 3 and 4 as these steps are interactive.

5. Set the RANGE switch to 100 mW. Adjust the 100 OFS, on the A2 assembly, for a reading of  $10.00 \pm 0.01$  mW.

**COMPARE MODE ADJUSTMENT**

1. Adjust the dc power supply to give exactly 100 mW indication on the Peak Power Meter. Connect the VIDEO OUTPUT to channel A of the oscilloscope. Connect the TRIGGER OUTPUT to the external trigger of the oscilloscope. Set the oscilloscope controls to 10 ms/div, and 0.05 V/div.

2. Set the MODE switch to COMPARE. Adjust the COMPARE LEVEL control so the two traces as displayed on the oscilloscope converge as one. Adjust COMP, on the A3 assembly, for a reading of 100 mW on the Peak Power Meter. It may be necessary to adjust the vertical position control on the oscilloscope to keep the trace in view. Disconnect the dc power supply from the green wire on the CORRECTION switch.

**VIDEO OUTPUT PULSE ADJUSTMENT**

Set the pulse generator to square wave, approximately 0.5V peak to peak, and 1 kHz repetition rate. (These pulse generator settings are approximate.) Connect the pulse generator output to the green wire terminal on the CORRECTION control. Set the oscilloscope controls to 0.2 volts per cm and  $1 \mu\text{s}$  per cm. Connect the oscilloscope channel A to the VIDEO OUTPUT. Adjust V PLS, on the A3 assembly, for the sharpest square wave as viewed on the oscilloscope. It may be necessary to adjust the oscilloscope vertical position control to keep the trace in view.

---



## SECTION VI REPLACEABLE PARTS

### 6-1. INTRODUCTION

This section contains information for ordering replacement parts for the Peak Power Meter. Table 6-1 lists abbreviations used in the parts list and throughout the manual. Table 6-2 lists all replaceable parts in reference designator order. Table 6-3 contains the names and addresses that correspond to the manufacturer's code numbers.

### 6-2. ABBREVIATIONS

Table 6-1 lists abbreviations used in the parts list, schematics, and throughout the manual. In some cases, two forms of the abbreviation are used, one all in capital letters, and one partial or no capitals. This occurs because the abbreviations in the parts list are always all capitals. However, in the schematics and other parts of the manual, other abbreviation forms are used with both lower case and upper case letters.

### 6-3. REPLACEABLE PARTS LIST

Table 6-2 is the list of replaceable parts and is organized as follows:

- a. Electrical assemblies and their components in alphanumeric order by reference designation.
- b. Chassis-mounted parts in alphanumeric order by reference designation.
- c. Mechanical parts.
- d. Illustrated parts breakdown.

The information given for each part consists of the following:

- a. The Hewlett-Packard part number.
- b. Part number check digit (CD).
- c. Total quantity (Qty) used in the instrument.
- d. Part description.
- e. Five-digit code that represents a typical manufacturer.

- f. Manufacturer's part number.

#### NOTE

*The total quantity for each part is given only once, that is, at the first occurrence of the part number in the list. The total quantities for optional assemblies are tallied by assembly and not integrated into the standard list.*

### 6-4. ORDERING INSTRUCTION

To order a part listed in the replaceable parts table, include the Hewlett-Packard part number (with the check digit), and the quantity required. Address the order to the nearest Hewlett-Packard office. The check digit will ensure accurate and timely processing of your order.

To order a part that is not listed in the replaceable parts table, include the instrument model number, instrument serial number, description and function of the part, and the number of parts required. Address the order to the nearest Hewlett-Packard office.

#### NOTE

*Within the USA, it is better to order directly from the HP Parts Center in Mountain View, California. Ask your nearest HP office for information and forms for the "Direct Mail Order System".*

### 6-5. PARTS PROVISIONING

Stocking spare parts for an instrument is often done to insure quick return to service after a malfunction occurs. Hewlett-Packard has a "Spare Parts Kit" available for this purpose. The kit consists of selected replaceable assemblies and components for this instrument. The contents of the kit and the "Recommended Spares" list are based on failure reports and repair data, and parts support for one year. A complimentary "Recommended Spares" list for this instrument may be obtained on request, and the "Spare Parts Kit" may be ordered through your nearest Hewlett-Packard office.

Table 6-1. Reference Designations and Abbreviations (1 of 2)

REFERENCE DESIGNATIONS

A . . . . . assembly	E . . . . . miscellaneous electrical part	P . . . . . electrical connector (movable portion); plug	U . . . . . integrated circuit; microcircuit
AT . . . . . attenuator; isolator; termination	F . . . . . fuse	Q . . . . . transistor: SCR; triode thyristor	V . . . . . electron tube
B . . . . . fan; motor	FL . . . . . filter	R . . . . . resistor	VR . . . . . voltage regulator; breakdown diode
BT . . . . . battery	H . . . . . hardware	RT . . . . . thermistor	W . . . . . cable; transmission path; wire
C . . . . . capacitor	HY . . . . . circulator	S . . . . . switch	X . . . . . socket
CP . . . . . coupler	J . . . . . electrical connector (stationary portion); jack	T . . . . . transformer	Y . . . . . crystal unit (piezo-electric or quartz)
CR . . . . . diode; diode thyristor; varactor	K . . . . . relay	TB . . . . . terminal board	Z . . . . . tuned cavity; tuned circuit
DC . . . . . directional coupler	L . . . . . coil; inductor	TC . . . . . thermocouple	
DL . . . . . delay line	M . . . . . meter	TP . . . . . test point	
DS . . . . . annunciator; signaling device (audible or visual); lamp; LED	MP . . . . . miscellaneous mechanical part		

ABBREVIATIONS

A . . . . . ampere	COEF . . . . . coefficient	EDP . . . . . electronic data processing	INT . . . . . internal
ac . . . . . alternating current	COM . . . . . common	ELECT . . . . . electrolytic	kg . . . . . kilogram
ACCESS . . . . . accessory	COMP . . . . . composition	ENCAP . . . . . encapsulated	kHz . . . . . kilohertz
ADJ . . . . . adjustment	COMPL . . . . . complete	EXT . . . . . external	k $\Omega$ . . . . . kilohm
A/D . . . . . analog-to-digital	CONN . . . . . connector	F . . . . . farad	kV . . . . . kilovolt
AF . . . . . audio frequency	CP . . . . . cadmium plate	FET . . . . . field-effect transistor	lb . . . . . pound
AFC . . . . . automatic frequency control	CRT . . . . . cathode-ray tube	F/F . . . . . flip-flop	LC . . . . . inductance-capacitance
AGC . . . . . automatic gain control	CTL . . . . . complementary transistor logic	FH . . . . . flat head	LED . . . . . light-emitting diode
AL . . . . . aluminum	CW . . . . . continuous wave	FIL H . . . . . fillister head	LF . . . . . low frequency
ALC . . . . . automatic level control	cm . . . . . centimeter	FM . . . . . frequency modulation	LG . . . . . long
AM . . . . . amplitude modulation	D/A . . . . . digital-to-analog	FP . . . . . front panel	LH . . . . . left hand
AMPL . . . . . amplifier	dB . . . . . decibel	FREQ . . . . . frequency	LIM . . . . . limit
APC . . . . . automatic phase control	dBm . . . . . decibel referred to 1 mW	FXD . . . . . fixed	LIN . . . . . linear taper (used in parts list)
ASSY . . . . . assembly	dc . . . . . direct current	g . . . . . gram	lin . . . . . linear
AUX . . . . . auxiliary	deg . . . . . degree (temperature interval or difference)	GE . . . . . germanium	LK WASH . . . . . lock washer
avg . . . . . average	° . . . . . degree (plane angle)	GHz . . . . . gigahertz	LO . . . . . low; local oscillator
AWG . . . . . American wire gauge	°C . . . . . degree Celsius (centigrade)	GL . . . . . glass	LOG . . . . . logarithmic taper (used in parts list)
BAL . . . . . balance	°F . . . . . degree Fahrenheit	GRD . . . . . ground(ed)	log . . . . . logarithm(ic)
BCD . . . . . binary coded decimal	K . . . . . degree Kelvin	H . . . . . henry	LPF . . . . . low pass filter
BD . . . . . board	DEPC . . . . . deposited carbon	h . . . . . hour	LV . . . . . low voltage
BE CU . . . . . beryllium copper	DET . . . . . detector	HET . . . . . heterodyne	m . . . . . meter (distance)
BFO . . . . . beat frequency oscillator	diam . . . . . diameter	HEX . . . . . hexagonal	mA . . . . . milliamper
BH . . . . . binder head	DIA . . . . . diameter (used in parts list)	HD . . . . . head	MAX . . . . . maximum
BKDN . . . . . breakdown	DIFF AMPL . . . . . differential amplifier	HDW . . . . . hardware	M $\Omega$ . . . . . megohm
BP . . . . . bandpass	div . . . . . division	HF . . . . . high frequency	MEG . . . . . meg (10 <sup>6</sup> ) (used in parts list)
BPF . . . . . bandpass filter	DPDT . . . . . double-pole, double-throw	HG . . . . . mercury	MET FLM . . . . . metal film
BRS . . . . . brass	DR . . . . . drive	HI . . . . . high	MET OX . . . . . metallic oxide
BWO . . . . . backward-wave oscillator	DSB . . . . . double sideband	HP . . . . . Hewlett-Packard	MF . . . . . medium frequency; microfarad (used in parts list)
CAL . . . . . calibrate	DTL . . . . . diode transistor logic	HPF . . . . . high pass filter	MFR . . . . . manufacturer
ccw . . . . . counter-clockwise	DVM . . . . . digital voltmeter	HR . . . . . hour (used in parts list)	mg . . . . . milligram
CER . . . . . ceramic	ECL . . . . . emitter coupled logic	HV . . . . . high voltage	MHz . . . . . megahertz
CHAN . . . . . channel	EMF . . . . . electromotive force	Hz . . . . . Hertz	mH . . . . . millihenry
cm . . . . . centimeter		IC . . . . . integrated circuit	mho . . . . . mho
CMO . . . . . cabinet mount only		ID . . . . . inside diameter	MIN . . . . . minimum
COAX . . . . . coaxial		IF . . . . . intermediate frequency	min . . . . . minute (time)
		IMPG . . . . . impregnated	... ' . . . . . minute (plane angle)
		in . . . . . inch	MINAT . . . . . miniature
		INCD . . . . . incandescent	mm . . . . . millimeter
		INCL . . . . . include(s)	
		INP . . . . . input	
		INS . . . . . insulation	

NOTE

All abbreviations in the parts list will be in upper-case.



Table 6-1. Reference Designations and Abbreviations (2 of 2)

MOD . . . . . modulator	OD . . . . . outside diameter	PWV . . . . . peak working voltage	TD . . . . . time delay
MOM . . . . . momentary	OH . . . . . oval head	RC . . . . . resistance-capacitance	TERM . . . . . terminal
MOS . . . . . metal-oxide semiconductor	OP AMPL . . . . . operational amplifier	RECT . . . . . rectifier	TFT . . . . . thin-film transistor
ms . . . . . millisecond	OPT . . . . . option	REF . . . . . reference	TGL . . . . . toggle
MTG . . . . . mounting	OSC . . . . . oscillator	REG . . . . . regulated	THD . . . . . thread
MTR . . . . . meter (indicating device)	OX . . . . . oxide	REPL . . . . . replaceable	THRU . . . . . through
mV . . . . . millivolt	oz . . . . . ounce	RF . . . . . radio frequency	TI . . . . . titanium
mVac . . . . . millivolt, ac	$\Omega$ . . . . . ohm	RFI . . . . . radio frequency interference	TOL . . . . . tolerance
mVdc . . . . . millivolt, dc	P . . . . . peak (used in parts list)	RH . . . . . round head; right hand	TRIM . . . . . trimmer
mVpk . . . . . millivolt, peak	PAM . . . . . pulse-amplitude modulation	RLC . . . . . resistance-inductance-capacitance	TSTR . . . . . transistor
mVp-p . . . . . millivolt, peak-to-peak	PC . . . . . printed circuit	RMO . . . . . rack mount only	TTL . . . . . transistor-transistor logic
mVrms . . . . . millivolt, rms	PCM . . . . . pulse-code modulation; pulse-count modulation	rms . . . . . root-mean-square	TV . . . . . television
mW . . . . . milliwatt	PDM . . . . . pulse-duration modulation	RND . . . . . round	TVI . . . . . television interference
MUX . . . . . multiplex	pF . . . . . picofarad	ROM . . . . . read-only memory	TWT . . . . . traveling wave tube
MY . . . . . mylar	PH BRZ . . . . . phosphor bronze	R&P . . . . . rack and panel	U . . . . . micro ( $10^{-6}$ ) (used in parts list)
$\mu$ A . . . . . microampere	PHL . . . . . Phillips	RWV . . . . . reverse working voltage	UF . . . . . microfarad (used in parts list)
$\mu$ F . . . . . microfarad	PIN . . . . . positive-intrinsic-negative	S . . . . . scattering parameter	UHF . . . . . ultrahigh frequency
$\mu$ H . . . . . microhenry	PIV . . . . . peak inverse voltage	s . . . . . second (time)	UNREG . . . . . unregulated
$\mu$ mho . . . . . micromho	pk . . . . . peak	." . . . . second (plane angle)	V . . . . . volt
$\mu$ s . . . . . microsecond	PL . . . . . phase lock	S-B . . . . . slow-blow (fuse) (used in parts list)	VA . . . . . voltampere
$\mu$ V . . . . . microvolt	PLO . . . . . phase lock oscillator	SCR . . . . . silicon controlled rectifier; screw	Vac . . . . . volts, ac
$\mu$ Vac . . . . . microvolt, ac	PM . . . . . phase modulation	SE . . . . . selenium	VAR . . . . . variable
$\mu$ Vdc . . . . . microvolt, dc	PNP . . . . . positive-negative-positive	SECT . . . . . sections	VCO . . . . . voltage-controlled oscillator
$\mu$ Vpk . . . . . microvolt, peak	P/O . . . . . part of	SEMICON . . . . . semiconductor	Vdc . . . . . volts, dc
$\mu$ Vp-p . . . . . microvolt, peak-to-peak	POLY . . . . . polystyrene	SHF . . . . . superhigh frequency	VDCW . . . . . volts, dc, working (used in parts list)
$\mu$ Vrms . . . . . microvolt, rms	PORC . . . . . porcelain	SI . . . . . silicon	V(F) . . . . . volts, filtered
$\mu$ W . . . . . microwatt	POS . . . . . positive; position(s) (used in parts list)	SIL . . . . . silver	VFO . . . . . variable-frequency oscillator
nA . . . . . nanoampere	POSN . . . . . position	SL . . . . . slide	VHF . . . . . very-high frequency
NC . . . . . no connection	POT . . . . . potentiometer	SNR . . . . . signal-to-noise ratio	Vpk . . . . . volts, peak
N/C . . . . . normally closed	P-P . . . . . peak-to-peak	SPDT . . . . . single-pole, double-throw	Vp-p . . . . . volts, peak-to-peak
NE . . . . . neon	PP . . . . . peak-to-peak (used in parts list)	SPG . . . . . spring	Vrms . . . . . volts, rms
NEG . . . . . negative	PPM . . . . . pulse-position modulation	SR . . . . . split ring	VSWR . . . . . voltage standing wave ratio
nF . . . . . nanofarad	PREAMPL . . . . . preamplifier	SPST . . . . . single-pole, single-throw	VTO . . . . . voltage-tuned oscillator
NI PL . . . . . nickel plate	PRF . . . . . pulse-repetition frequency	SSB . . . . . single sideband	VTVM . . . . . vacuum-tube voltmeter
N/O . . . . . normally open	PRR . . . . . pulse repetition rate	SST . . . . . stainless steel	V(X) . . . . . volts, switched
NOM . . . . . nominal	ps . . . . . picosecond	STL . . . . . steel	W . . . . . watt
NORM . . . . . normal	PT . . . . . point	SQ . . . . . square	W/ . . . . . with
NPN . . . . . negative-positive-negative	PTM . . . . . pulse-time modulation	SWR . . . . . standing-wave ratio	WIV . . . . . working inverse voltage
NPO . . . . . negative-positive zero (zero temperature coefficient)	PWM . . . . . pulse-width modulation	SYNC . . . . . synchronize	WW . . . . . wirewound
NRFR . . . . . not recommended for field replacement		T . . . . . timed (slow-blow fuse)	W/O . . . . . without
NSR . . . . . not separately replaceable		TA . . . . . tantalum	YIG . . . . . yttrium-iron-garnet
ns . . . . . nanosecond		TC . . . . . temperature compensating	Z <sub>0</sub> . . . . . characteristic impedance
nW . . . . . nanowatt			
OBD . . . . . order by description			

NOTE

All abbreviations in the parts list will be in upper-case.

MULTIPLIERS

Abbreviation	Prefix	Multiple
T	tera	$10^{12}$
G	giga	$10^9$
M	mega	$10^6$
k	kilo	$10^3$
da	deka	10
d	deci	$10^{-1}$
c	centi	$10^{-2}$
m	milli	$10^{-3}$
$\mu$	micro	$10^{-6}$
n	nano	$10^{-9}$
p	pico	$10^{-12}$
f	femto	$10^{-15}$
a	atto	$10^{-18}$

Table 6-2. Replaceable Parts

Reference Designation	HP Part Number	C D	Qty	Description	Mfr Code	Mfr Part Number
A1	08900-60219	0	1	INTERCONNECT "D" BOARD ASSEMBLY	28480	08900-60219
A1J1	1251-0600	0	46	CONNECTOR-SGL CONT PIN 1.14-MM-BSC-SZ SQ	28480	1251-0600
A1J2	1251-0600	0		CONNECTOR-SGL CONT PIN 1.14-MM-BSC-SZ SQ	28480	1251-0600
A1J3	1251-0600	0		CONNECTOR-SGL CONT PIN 1.14-MM-BSC-SZ SQ	28480	1251-0600
A1J4	1251-0600	0		CONNECTOR-SGL CONT PIN 1.14-MM-BSC-SZ SQ	28480	1251-0600
A1J5	1251-0600	0		CONNECTOR-SGL CONT PIN 1.14-MM-BSC-SZ SQ	28480	1251-0600
A1J6	1251-0600	0		CONNECTOR-SGL CONT PIN 1.14-MM-BSC-SZ SQ	28480	1251-0600
A1J7	1251-0600	0		CONNECTOR-SGL CONT PIN 1.14-MM-BSC-SZ SQ	28480	1251-0600
A1J8	1251-0600	0		CONNECTOR-SGL CONT PIN 1.14-MM-BSC-SZ SQ	28480	1251-0600
A1J9	1251-0600	0		CONNECTOR-SGL CONT PIN 1.14-MM-BSC-SZ SQ	28480	1251-0600
A1J10	1251-0600	0		CONNECTOR-SGL CONT PIN 1.14-MM-BSC-SZ SQ	28480	1251-0600
A1J11	1251-0600	0	CONNECTOR-SGL CONT PIN 1.14-MM-BSC-SZ SQ	28480	1251-0600	
A1J12	1251-0600	0	CONNECTOR-SGL CONT PIN 1.14-MM-BSC-SZ SQ	28480	1251-0600	
A1MP1				SWITCH GUIDE (NSR P/O A1)		
A1MP2				SWITCH GUIDE (NSR P/O A1)		
A1MP3				SWITCH GUIDE (NSR P/O A1)		
A1R1	0698-3434	9	1	RESISTOR 34.8 1% .125W F TC=0+-100	24546	C4-1/8-T0-34R8-F
A1R2	0698-3431	6	1	RESISTOR 23.7 1% .125W F TC=0+-100	03888	PME55-1/8-T0-23R7-F
A1R3	2100-2010	2	1	RESISTOR-TRMR 10 20% C TOP-ADJ 1-TRN	73138	82PR10
A1R4	0757-0401	0	10	RESISTOR 100 1% .125W F TC=0+-100	24546	C4-1/8-T0-101-F
A1S1	08900-60234	9	1	SLIDE SWITCH ASSEMBLY	28480	08900-60234
	5020-3440	7	3	SPRING-DETENT	28480	5020-3440
A1S2	08900-60233	8	2	SLIDE SWITCH ASSEMBLY	28480	08900-60233
	5020-3440	7		SPRING-DETENT	28480	5020-3440
A1S3	08900-60233	8		SLIDE SWITCH ASSEMBLY	28480	08900-60233
	5020-3440	7		SPRING-DETENT	28480	5020-3440
A1XA3	1251-2035	9	1	CONNECTOR-PC EDGE 15-CONT/ROW 2-ROWS	28480	1251-2035
A2	08900-60216	7	1	SHAPING BOARD ASSEMBLY	28480	08900-60216
A2C1	0160-3879	7	10	CAPACITOR-FXD .01UF +-20% 100VDC CER	28480	0160-3879
A2C2	0160-3879	7		CAPACITOR-FXD .01UF +-20% 100VDC CER	28480	0160-3879
A2C3	0160-3879	7		CAPACITOR-FXD .01UF +-20% 100VDC CER	28480	0160-3879
A2C4	0160-3879	7		CAPACITOR-FXD .01UF +-20% 100VDC CER	28480	0160-3879
A2C5	0160-3879	7		CAPACITOR-FXD .01UF +-20% 100VDC CER	28480	0160-3879
A2C6	0160-3879	7		CAPACITOR-FXD .01UF +-20% 100VDC CER	28480	0160-3879
A2C7	0160-3879	7		CAPACITOR-FXD .01UF +-20% 100VDC CER	28480	0160-3879
A2C8	0160-3879	7		CAPACITOR-FXD .01UF +-20% 100VDC CER	28480	0160-3879
A2C9	0160-3879	7		CAPACITOR-FXD .01UF +-20% 100VDC CER	28480	0160-3879
A2C10	0160-3879	7		CAPACITOR-FXD .01UF +-20% 100VDC CER	28480	0160-3879
A2C11	0160-4387	4	1	CAPACITOR-FXD 47PF +-5% 200VDC CER 0+-30	28480	0160-4387
A2CR1	1901-0050	3	30	DIODE-SWITCHING 80V 200MA 2NS DO-35	28480	1901-0050
A2CR2	1901-0050	3		DIODE-SWITCHING 80V 200MA 2NS DO-35	28480	1901-0050
A2CR3	1901-0050	3		DIODE-SWITCHING 80V 200MA 2NS DO-35	28480	1901-0050
A2CR4	1901-0050	3		DIODE-SWITCHING 80V 200MA 2NS DO-35	28480	1901-0050
A2CR5	1901-0050	3		DIODE-SWITCHING 80V 200MA 2NS DO-35	28480	1901-0050
A2CR6	1901-0050	3		DIODE-SWITCHING 80V 200MA 2NS DO-35	28480	1901-0050
A2CR7	1901-0050	3		DIODE-SWITCHING 80V 200MA 2NS DO-35	28480	1901-0050
A2CR8	1901-0050	3		DIODE-SWITCHING 80V 200MA 2NS DO-35	28480	1901-0050
A2CR9	1901-0050	3		DIODE-SWITCHING 80V 200MA 2NS DO-35	28480	1901-0050
A2CR10	1901-0050	3		DIODE-SWITCHING 80V 200MA 2NS DO-35	28480	1901-0050
A2CR11	1901-0050	3	DIODE-SWITCHING 80V 200MA 2NS DO-35	28480	1901-0050	
A2CR12	1901-0050	3	DIODE-SWITCHING 80V 200MA 2NS DO-35	28480	1901-0050	
A2CR13	1901-0050	3	DIODE-SWITCHING 80V 200MA 2NS DO-35	28480	1901-0050	
A2CR14	1901-0050	3	DIODE-SWITCHING 80V 200MA 2NS DO-35	28480	1901-0050	
A2CR15	1901-0050	3	DIODE-SWITCHING 80V 200MA 2NS DO-35	28480	1901-0050	
A2CR16	1901-0050	3	DIODE-SWITCHING 80V 200MA 2NS DO-35	28480	1901-0050	
A2CR17	1901-0050	3	DIODE-SWITCHING 80V 200MA 2NS DO-35	28480	1901-0050	
A2CR18	1901-0050	3	DIODE-SWITCHING 80V 200MA 2NS DO-35	28480	1901-0050	
A2CR19	1901-0050	3	DIODE-SWITCHING 80V 200MA 2NS DO-35	28480	1901-0050	
A2CR20	1901-0050	3	DIODE-SWITCHING 80V 200MA 2NS DO-35	28480	1901-0050	

See introduction to this section for ordering information

Table 6-2. Replaceable Parts

Reference Designation	HP Part Number	C D	Qty	Description	Mfr Code	Mfr Part Number
A2CR21	1901-0050	3		DIODE-SWITCHING 80V 200MA 2NS DO-35	28480	1901-0050
A2CR22	1901-0050	3		DIODE-SWITCHING 80V 200MA 2NS DO-35	28480	1901-0050
A2CR23	1901-0050	3		DIODE-SWITCHING 80V 200MA 2NS DO-35	28480	1901-0050
A2CR24	1901-0050	3		DIODE-SWITCHING 80V 200MA 2NS DO-35	28480	1901-0050
A2CR25	1901-0050	3		DIODE-SWITCHING 80V 200MA 2NS DO-35	28480	1901-0050
A2CR26	1901-0050	3		DIODE-SWITCHING 80V 200MA 2NS DO-35	28480	1901-0050
A2CR27	1901-0050	3		DIODE-SWITCHING 80V 200MA 2NS DO-35	28480	1901-0050
A2CR28	1901-0050	3		DIODE-SWITCHING 80V 200MA 2NS DO-35	28480	1901-0050
A2CR29	1901-0050	3		DIODE-SWITCHING 80V 200MA 2NS DO-35	28480	1901-0050
A2CR30	1901-0050	3		DIODE-SWITCHING 80V 200MA 2NS DO-35	28480	1901-0050
A2CR31	1901-0040	1	2	DIODE-SWITCHING 30V 50MA 2NS DO-35	28480	1901-0040
A2CR32	1901-0040	1		DIODE-SWITCHING 30V 50MA 2NS DO-35	28480	1901-0040
A2K1	0490-1013	6	2	RELAY-REED 1C 250MA 28VDC 5VDC-COIL 3VA	28480	0490-1013
A2K2	0490-1013	6		RELAY-REED 1C 250MA 28VDC 5VDC-COIL 3VA	28480	0490-1013
A2Q1	1854-0810	2	2	TRANSISTOR NPN SI PD=625MW FT=200MHZ	28480	1854-0810
A2Q2	1854-0810	2		TRANSISTOR NPN SI PD=625MW FT=200MHZ	28480	1854-0810
A2R1	0698-4157	5	31	RESISTOR 10K .1% .125W F TC=0+-50	28480	0698-4157
A2R2	0698-4157	5		RESISTOR 10K .1% .125W F TC=0+-50	28480	0698-4157
A2R3	0698-4157	5		RESISTOR 10K .1% .125W F TC=0+-50	28480	0698-4157
A2R4	0698-4157	5		RESISTOR 10K .1% .125W F TC=0+-50	28480	0698-4157
A2R5	0698-4157	5		RESISTOR 10K .1% .125W F TC=0+-50	28480	0698-4157
A2R6	0698-4157	5		RESISTOR 10K .1% .125W F TC=0+-50	28480	0698-4157
A2R7	0698-4157	5		RESISTOR 10K .1% .125W F TC=0+-50	28480	0698-4157
A2R8	0698-4157	5		RESISTOR 10K .1% .125W F TC=0+-50	28480	0698-4157
A2R9	0699-0272	9	2	RESISTOR 75K .1% .125W F TC=0+-25	28480	0699-0272
A2R10	0698-8642	1	2	RESISTOR 56.2K .1% .125W F TC=0+-25	28480	0698-8642
A2R11	0698-3934	4	2	RESISTOR 42.18K .1% .125W F TC=0+-25	28480	0698-3934
A2R12	0698-8851	4	1	RESISTOR 34.7K .1% .125W F TC=0+-25	28480	0698-8851
A2R13	0698-7375	5	1	RESISTOR 28.64K .1% .125W F TC=0+-50	19701	MF4C1/8-T2-28641-B
A2R14	0698-7670	3	2	RESISTOR 23.69K .1% .125W F TC=0+-50	19701	MF4C1/8-T2-23691-B
A2R15	0698-8168	6	1	RESISTOR 20.51K .1% .125W F TC=0+-25	19701	MF4C1/8-T9-20511-B
A2R16	0757-0444	1	1	RESISTOR 12.1K 1% .125W F TC=0+-100	24546	C4-1/8-T0-1212-F
A2R17	0698-4157	5		RESISTOR 10K .1% .125W F TC=0+-50	28480	0698-4157
A2R18	0698-3449	6	3	RESISTOR 28.7K 1% .125W F TC=0+-100	24546	C4-1/8-T0-2872-F
A2R19	0698-4157	5		RESISTOR 10K .1% .125W F TC=0+-50	28480	0698-4157
A2R20	0698-4157	5		RESISTOR 10K .1% .125W F TC=0+-50	28480	0698-4157
A2R21	0698-4157	5		RESISTOR 10K .1% .125W F TC=0+-50	28480	0698-4157
A2R22	0698-4157	5		RESISTOR 10K .1% .125W F TC=0+-50	28480	0698-4157
A2R23	0698-4157	5		RESISTOR 10K .1% .125W F TC=0+-50	28480	0698-4157
A2R24	0698-4157	5		RESISTOR 10K .1% .125W F TC=0+-50	28480	0698-4157
A2R25	0698-4157	5		RESISTOR 10K .1% .125W F TC=0+-50	28480	0698-4157
A2R26	0698-4157	5		RESISTOR 10K .1% .125W F TC=0+-50	28480	0698-4157
A2R27	0698-3443	0	1	RESISTOR 287 1% .125W F TC=0+-100	24546	C4-1/8-T0-287R-F
A2R28	0698-7933	1	4	RESISTOR 3.83K .1% .125W F TC=0+-25	19701	MF4C1/8-T9-3831-B
A2R29	0699-0842	9	4	RESISTOR 6.19K .1% .125W F TC=0+-25	28480	0699-0842
A2R30	0699-0842	9		RESISTOR 6.19K .1% .125W F TC=0+-25	28480	0699-0842
A2R31	0757-1094	9	1	RESISTOR 1.47K 1% .125W F TC=0+-100	24546	C4-1/8-T0-1471-F
A2R32	0757-0420	3	1	RESISTOR 750 1% .125W F TC=0+-100	24546	C4-1/8-T0-751-F
A2R33	0698-7933	1		RESISTOR 3.83K .1% .125W F TC=0+-25	19701	MF4C1/8-T9-3831-B
A2R34	0699-0843	0	2	RESISTOR 2.87K .1% .125W F TC=0+-25	28480	0699-0843
A2R35	2100-2497	9	1	RESISTOR-TRMR 2K 10% C TOP-ADJ 1-TRN	73138	82PR2K
A2R36	0699-0902	2	1	RESISTOR 3.48K .1% .125W F TC=0+-50	28480	0699-0902
A2R37	0698-7232	3	1	RESISTOR 681 1% .05W F TC=0+-100	24546	C3-1/8-T0-681R-F
A2R38	0757-0417	8	2	RESISTOR 562 1% .125W F TC=0+-100	24546	C4-1/8-T0-562R-F
A2R39	0698-3441	8	2	RESISTOR 215 1% .125W F TC=0+-100	24546	C4-1/8-T0-215R-F
A2R40	0699-0842	9		RESISTOR 6.19K .1% .125W F TC=0+-25	28480	0699-0842
A2R41	0698-7933	1		RESISTOR 3.83K .1% .125W F TC=0+-25	19701	MF4C1/8-T9-3831-B
A2R42	0698-3132	4	3	RESISTOR 261 1% .125W F TC=0+-100	24546	C4-1/8-T0-2610-F
A2R43	0698-3132	4		RESISTOR 261 1% .125W F TC=0+-100	24546	C4-1/8-T0-2610-F
A2R44	0698-4157	5		RESISTOR 10K .1% .125W F TC=0+-50	28480	0698-4157
A2R45	0698-4157	5		RESISTOR 10K .1% .125W F TC=0+-50	28480	0698-4157
A2R46	0698-4157	5		RESISTOR 10K .1% .125W F TC=0+-50	28480	0698-4157
A2R47	0698-4157	5		RESISTOR 10K .1% .125W F TC=0+-50	28480	0698-4157
A2R48	0698-4157	5		RESISTOR 10K .1% .125W F TC=0+-50	28480	0698-4157
A2R49	0698-4157	5		RESISTOR 10K .1% .125W F TC=0+-50	28480	0698-4157
A2R50	0698-4157	5		RESISTOR 10K .1% .125W F TC=0+-50	28480	0698-4157

See introduction to this section for ordering information

Table 6-2. Replaceable Parts

Reference Designation	HP Part Number	C	D	Qty	Description	Mfr Code	Mfr Part Number
A2R51					NOT ASSIGNED		
A2R52	0699-0575	5		1	RESISTOR 133K .1% .1W F TC=0+-15	28480	0699-0575
A2R53	0699-0272	9			RESISTOR 75K .1% .125W F TC=0+-25	28480	0699-0272
A2R54	0698-8642	1			RESISTOR 56.2K .1% .125W F TC=0+-25	28480	0698-8642
A2R55	0698-3934	4			RESISTOR 42.18K .1% .125W F TC=0+-25	28480	0698-3934
A2R56	0698-6991	9		1	RESISTOR 31.6K .1% .125W F TC=0+-50	28480	0698-6991
A2R57	0698-7670	3			RESISTOR 23.69K .1% .125W F TC=0+-50	19701	MF4C1/8-T2-23691-B
A2R58	0698-4157	5			RESISTOR 10K .1% .125W F TC=0+-50	28480	0698-4157
A2R59	0698-4157	5			RESISTOR 10K .1% .125W F TC=0+-50	28480	0698-4157
A2R60	0698-4157	5			RESISTOR 10K .1% .125W F TC=0+-50	28480	0698-4157
A2R61	0698-4157	5			RESISTOR 10K .1% .125W F TC=0+-50	28480	0698-4157
A2R62	0698-4157	5			RESISTOR 10K .1% .125W F TC=0+-50	28480	0698-4157
A2R63	0698-4157	5			RESISTOR 10K .1% .125W F TC=0+-50	28480	0698-4157
A2R64	0698-4157	5			RESISTOR 10K .1% .125W F TC=0+-50	28480	0698-4157
A2R65	0757-0398	4		2	RESISTOR 75 1% .125W F TC=0+-100	24546	C4-1/8-T0-75R0-F
A2R66	0698-3132	4			RESISTOR 261 1% .125W F TC=0+-100	24546	C4-1/8-T0-2610-F
A2R67	0757-0416	7		1	RESISTOR 511 1% .125W F TC=0+-100	24546	C4-1/8-T0-511R-F
A2R68	0698-6616	5		1	RESISTOR 750 .1% .125W F TC=0+-25	28480	0698-6616
A2R69	0698-3438	3		1	RESISTOR 147 1% .125W F TC=0+-100	24546	C4-1/8-T0-147R-F
A2R70	0757-0398	4			RESISTOR 75 1% .125W F TC=0+-100	24546	C4-1/8-T0-75R0-F
A2R71	0698-3439	4		1	RESISTOR 178 1% .125W F TC=0+-100	24546	C4-1/8-T0-178R-F
A2R72	0699-0843	0			RESISTOR 2.87K .1% .125W F TC=0+-25	28480	0699-0843
A2R73	0699-0842	9			RESISTOR 6.19K .1% .125W F TC=0+-25	28480	0699-0842
A2R74	0698-8061	8		2	RESISTOR 8.25K .1% .125W F TC=0+-25	19701	MF4C1/8-T9-8251-B
A2R75	0698-8061	8			RESISTOR 8.25K .1% .125W F TC=0+-25	19701	MF4C1/8-T9-8251-B
A2R76	0698-8657	8		1	RESISTOR 6.81K .1% .125W F TC=0+-50	28480	0698-8657
A2R77	0699-0533	5		1	RESISTOR 4.64K .1% .125W F TC=0+-25	28480	0699-0533
A2R78	0698-7933	1			RESISTOR 3.83K .1% .125W F TC=0+-25	19701	MF4C1/8-T9-3831-B
A2R79	0698-3445	2		1	RESISTOR 348 1% .125W F TC=0+-100	24546	C4-1/8-T0-348R-F
A2R80	0698-3157	3		5	RESISTOR 19.6K 1% .125W F TC=0+-100	24546	C4-1/8-T0-1962-F
A2R81	2100-2030	6		1	RESISTOR-TRMR 20K 10% C TOP-ADJ 1-TRN	73138	82PR20K
A2R82	0698-3157	3			RESISTOR 19.6K 1% .125W F TC=0+-100	24546	C4-1/8-T0-1962-F
A2R83	0698-3446	3		1	RESISTOR 393 1% .125W F TC=0+-100	24546	C4-1/8-T0-393R-F
A2R84	0698-3157	3			RESISTOR 19.6K 1% .125W F TC=0+-100	24546	C4-1/8-T0-1962-F
A2R85	0698-3157	3			RESISTOR 19.6K 1% .125W F TC=0+-100	24546	C4-1/8-T0-1962-F
A2R86	2100-1738	9		1	RESISTOR-TRMR 10K 10% C TOP-ADJ 1-TRN	73138	82PR10K
A2R87	0698-7649	6		1	RESISTOR 393 .1% .125W F TC=0+-25	19701	MF4C1/8-T9-393R-B
A2R88	0757-0421	4		1	RESISTOR 825 1% .125W F TC=0+-100	24546	C4-1/8-T0-825R-F
A2R89	0698-8818	3		1	RESISTOR 3.16 1% .125W F TC=0+-100	28480	0698-8818
A2TP1	1251-0600	0			CONNECTOR-SGL CONT PIN 1.14-MM-BSC-SZ SQ	28480	1251-0600
A2TP2	1251-0600	0			CONNECTOR-SGL CONT PIN 1.14-MM-BSC-SZ SQ	28480	1251-0600
A2TP3	1251-0600	0			CONNECTOR-SGL CONT PIN 1.14-MM-BSC-SZ SQ	28480	1251-0600
A2TP4	1251-0600	0			CONNECTOR-SGL CONT PIN 1.14-MM-BSC-SZ SQ	28480	1251-0600
A2TP5	1251-0600	0			CONNECTOR-SGL CONT PIN 1.14-MM-BSC-SZ SQ	28480	1251-0600
A2TP6	1251-0600	0			CONNECTOR-SGL CONT PIN 1.14-MM-BSC-SZ SQ	28480	1251-0600
A2U1	1826-0323	3		4	IC OP AMP GP QUAD 14-DIP-C PKG	28480	1826-0323
A2U2	1826-0323	3			IC OP AMP GP QUAD 14-DIP-C PKG	28480	1826-0323
A2U3	1826-0323	3			IC OP AMP GP QUAD 14-DIP-C PKG	28480	1826-0323
A2U4	1826-0323	3			IC OP AMP GP QUAD 14-DIP-C PKG	28480	1826-0323
A2U5	1826-0013	8		2	IC OP AMP LOW-NOISE T0-99 PKG	06665	SSS741CJ
A2VR1	1902-0948	0		2	DIODE-ZNR 3.9V 5% DO-35 PD=.4W TC=-.012%	28480	1902-0948
A2VR2	1902-0948	0			DIODE-ZNR 3.9V 5% DO-35 PD=.4W TC=-.012%	28480	1902-0948
A3	08900-60214	5		1	MOTHERBOARD ASSEMBLY	28480	08900-60214
A3C1	0170-0040	9		1	CAPACITOR-FXD .047UF +-10% 200VDC POLYE	56289	292P47392
A3C2	0160-2055	9		6	CAPACITOR-FXD .01UF +80-20% 100VDC CER	28480	0160-2055
A3C3	0160-2055	9			CAPACITOR-FXD .01UF +80-20% 100VDC CER	28480	0160-2055
A3C4	0160-2055	9			CAPACITOR-FXD .01UF +80-20% 100VDC CER	28480	0160-2055
A3C5	0180-2102	9		2	CAPACITOR-FXD 700UF+75-10% 25VDC AL	28480	0180-2102
A3C6	0180-2102	9			CAPACITOR-FXD 700UF+75-10% 25VDC AL	28480	0180-2102
A3C7	0180-2619	3		3	CAPACITOR-FXD 22UF+-10% 15VDC TA	25088	D22G51B15K
A3C8	0160-3501	2		1	CAPACITOR-FXD 4UF +-10% 50VDC MET-POLYC	28480	0160-3501
A3C9	0160-0127	2		8	CAPACITOR-FXD 1UF +-20% 25VDC CER	28480	0160-0127
A3C10	0160-0127	2			CAPACITOR-FXD 1UF +-20% 25VDC CER	28480	0160-0127

See introduction to this section for ordering information

Table 6-2. Replaceable Parts

Reference Designation	HP Part Number	C D	Qty	Description	Mfr Code	Mfr Part Number
A3C11	0160-4766	3	1	CAPACITOR-FXD 30PF +-5% 200VDC CER 0+-30	28480	0160-4766
A3C12	0180-0229	7	3	CAPACITOR-FXD 33UF+-10% 10VDC TA	56289	150D336X9010B2
A3C13	0180-0229	7		CAPACITOR-FXD 33UF+-10% 10VDC TA	56289	150D336X9010B2
A3C14	0160-2055	9		CAPACITOR-FXD .01UF +80-20% 100VDC CER	28480	0160-2055
A3C15	0160-2055	9		CAPACITOR-FXD .01UF +80-20% 100VDC CER	28480	0160-2055
A3C16	0160-0127	2		CAPACITOR-FXD 1UF +-20% 25VDC CER	28480	0160-0127
A3C17	0160-0127	2		CAPACITOR-FXD 1UF +-20% 25VDC CER	28480	0160-0127
A3C18	0160-0127	2		CAPACITOR-FXD 1UF +-20% 25VDC CER	28480	0160-0127
A3C19	0160-0127	2		CAPACITOR-FXD 1UF +-20% 25VDC CER	28480	0160-0127
A3C20	0180-0229	7		CAPACITOR-FXD 33UF+-10% 10VDC TA	56289	150D336X9010B2
A3C21	0160-0127	2		CAPACITOR-FXD 1UF +-20% 25VDC CER	28480	0160-0127
A3C22	0160-0127	2		CAPACITOR-FXD 1UF +-20% 25VDC CER	28480	0160-0127
A3C23	0160-0166	9	1	CAPACITOR-FXD .068UF +-10% 200VDC POLYE	28480	0160-0166
A3C24	0180-2206	4	1	CAPACITOR-FXD 60UF+-10% 6VDC TA	56289	150D606X9006B2
A3C25	0160-2055	9		CAPACITOR-FXD .01UF +80-20% 100VDC CER	28480	0160-2055
A3C26	0180-2619	3		CAPACITOR-FXD 22UF+-10% 15VDC TA	25088	D22GS1B15K
A3C27	0180-2619	3		CAPACITOR-FXD 22UF+-10% 15VDC TA	25088	D22GS1B15K
A3C28	0180-0374	3	2	CAPACITOR-FXD 10UF+-10% 20VDC TA	56289	150D106X9020B2
A3C29	0180-0374	3		CAPACITOR-FXD 10UF+-10% 20VDC TA	56289	150D106X9020B2
A3C30	0160-0576	5	5	CAPACITOR-FXD .1UF +-20% 50VDC CER	28480	0160-0576
A3C31	0160-4765	2	1	CAPACITOR-FXD 36PF +-5% 200VDC CER 0+-30	28480	0160-4765
A3C32	0160-2239	1	1	CAPACITOR-FXD 1.8PF +-25PF 500VDC CER	28480	0160-2239
A3C33	0121-0105	4	1	CAPACITOR-V TRMR-CER 9-35PF 200V PC-MTG	52763	304324 9/35PF N650
A3CR1	1901-0179	7	6	DIODE-SWITCHING 15V 50MA 750PS DO-7	28480	1901-0179
A3CR2	1901-0327	7	4	DIODE-PWR RECT 200V 1A 6US	03508	A14B
A3CR3	1901-0327	7		DIODE-PWR RECT 200V 1A 6US	03508	A14B
A3CR4	1901-0327	7		DIODE-PWR RECT 200V 1A 6US	03508	A14B
A3CR5	1901-0327	7		DIODE-PWR RECT 200V 1A 6US	03508	A14B
A3CR6	1901-0179	7		DIODE-SWITCHING 15V 50MA 750PS DO-7	28480	1901-0179
A3CR7	1902-0950	4	2	DIODE-ZNR 4.7V 5% DO-35 PD=.4W TC=+.025%	28480	1902-0950
A3CR8	1901-0179	7		DIODE-SWITCHING 15V 50MA 750PS DO-7	28480	1901-0179
A3CR9	1901-0179	7		DIODE-SWITCHING 15V 50MA 750PS DO-7	28480	1901-0179
A3CR10	1901-0179	7		DIODE-SWITCHING 15V 50MA 750PS DO-7	28480	1901-0179
A3CR11	1901-0179	7		DIODE-SWITCHING 15V 50MA 750PS DO-7	28480	1901-0179
A3CR12	1902-0950	4		DIODE-ZNR 4.7V 5% DO-35 PD=.4W TC=+.025%	28480	1902-0950
A3CR13	1901-0033	2	1	DIODE-GEN PRP 180V 200MA DO-7	28480	1901-0033
A3J1	1251-0600	0		CONNECTOR-SGL CONT PIN 1.14-MM-BSC-SZ SQ	28480	1251-0600
A3J2	1251-0600	0		CONNECTOR-SGL CONT PIN 1.14-MM-BSC-SZ SQ	28480	1251-0600
A3J3	1251-0600	0		CONNECTOR-SGL CONT PIN 1.14-MM-BSC-SZ SQ	28480	1251-0600
A3J4	1251-0600	0		CONNECTOR-SGL CONT PIN 1.14-MM-BSC-SZ SQ	28480	1251-0600
A3J5	1251-0600	0		CONNECTOR-SGL CONT PIN 1.14-MM-BSC-SZ SQ	28480	1251-0600
A3J6	1251-0600	0		CONNECTOR-SGL CONT PIN 1.14-MM-BSC-SZ SQ	28480	1251-0600
A3J7	1251-0600	0		CONNECTOR-SGL CONT PIN 1.14-MM-BSC-SZ SQ	28480	1251-0600
A3J8	1251-0600	0		CONNECTOR-SGL CONT PIN 1.14-MM-BSC-SZ SQ	28480	1251-0600
A3MP1	2200-0141	8	2	SCREW-MACH 4-40 .312-IN-LG PAN-HD-POZI	28480	2200-0141
A3MP2	2200-0141	8		SCREW-MACH 4-40 .312-IN-LG PAN-HD-POZI	28480	2200-0141
A3MP3	2260-0009	3	3	NUT-HEX-W/LKWR 4-40-THD .094-IN-THK	00000	ORDER BY DESCRIPTION
A3MP4	2260-0009	3		NUT-HEX-W/LKWR 4-40-THD .094-IN-THK	00000	ORDER BY DESCRIPTION
A3MP5	3050-0105	6	3	WASHER-FL MTLN NO. 4 .125-IN-ID	28480	3050-0105
A3MP6	3050-0105	6		WASHER-FL MTLN NO. 4 .125-IN-ID	28480	3050-0105
A3Q1	1854-0811	3	1	TRANSISTOR NPN SI PD=625MW FT=100MHZ	28480	1854-0811
A3Q2	1853-0281	9		TRANSISTOR PNP 2N2907A SI T0-18 PD=400MW	04713	2N2907A
A3Q3	1853-0405	9		TRANSISTOR PNP SI PD=300MW FT=850MHZ	04713	2N4209
A3Q4	1854-0477	7	2	TRANSISTOR NPN 2N2222A SI T0-18 PD=500MW	04713	2N2222A
A3Q5	1854-0457	3	2	TRANSISTOR-DUAL NPN PD=400MW	28480	1854-0457
A3Q6	1854-0457	3		TRANSISTOR-DUAL NPN PD=400MW	28480	1854-0457
A3R1	0757-0417	8		RESISTOR 562 1% .125W F TC=0+-100	24546	C4-1/8-T0-562R-F
A3R2	0757-0401	0		RESISTOR 100 1% .125W F TC=0+-100	24546	C4-1/8-T0-101-F
A3R3	2100-2413	9	2	RESISTOR-TRMR 200 10% C SIDE-ADJ 1-TRN	30983	ET50X201
A3R4	0698-8820	7	1	RESISTOR 4.64 1% .125W F TC=0+-100	28480	0698-8820
A3R5	0757-0280	3	4	RESISTOR 1K 1% .125W F TC=0+-100	24546	C4-1/8-T0-1001-F

See introduction to this section for ordering information

Table 6-2. Replaceable Parts

Reference Designation	HP Part Number	C D	Qty	Description	Mfr Code	Mfr Part Number
A3R6	0757-0279	0	1	RESISTOR 3.16K 1% .125W F TC=0+-100	24546	C4-1/8-T0-3161-F
A3R7	2100-2517	4	1	RESISTOR-TRMR 50K 10% C SIDE-ADJ 1-TRN	30983	ET50X503
A3R8	2100-2489	9	2	RESISTOR-TRMR 5K 10% C SIDE-ADJ 1-TRN	30983	ET50X502
A3R9	0757-0317	7	1	RESISTOR 1.33K 1% .125W F TC=0+-100	24546	C4-1/8-T0-1331-F
A3R10	0698-3159	5	1	RESISTOR 26.1K 1% .125W F TC=0+-100	24546	C4-1/8-T0-2612-F
A3R11	0698-3440	7	1	RESISTOR 196 1% .125W F TC=0+-100	24546	C4-1/8-T0-196R-F
A3R12	0757-0346	2	3	RESISTOR 10 1% .125W F TC=0+-100	24546	C4-1/8-T0-10R0-F
A3R13	0757-0401	0		RESISTOR 100 1% .125W F TC=0+-100	24546	C4-1/8-T0-101-F
A3R14	0757-0401	0		RESISTOR 100 1% .125W F TC=0+-100	24546	C4-1/8-T0-101-F
A3R15	0757-0401	0		RESISTOR 100 1% .125W F TC=0+-100	24546	C4-1/8-T0-101-F
A3R16	0757-0428	1	1	RESISTOR 1.62K 1% .125W F TC=0+-100	24546	C4-1/8-T0-1621-F
A3R17	0698-8827	4	1	RESISTOR 1M 1% .125W F TC=0+-100	28480	0698-8827
A3R18	0698-8814	9	1	RESISTOR 1.47 1% .125W F TC=0+-100	28480	0698-8814
A3R19	0757-0443	0	1	RESISTOR 11K 1% .125W F TC=0+-100	24546	C4-1/8-T0-1102-F
A3R20	0698-3442	9	1	RESISTOR 237 1% .125W F TC=0+-100	24546	C4-1/8-T0-237R-F
A3R21	2100-1985	8	1	RESISTOR-TRMR 20 20% C TOP-ADJ 1-TRN	32997	3329H-1-200
A3R22	0698-3444	1	1	RESISTOR 316 1% .125W F TC=0+-100	24546	C4-1/8-T0-316R-F
A3R23	2100-2060	2	1	RESISTOR-TRMR 50 20% C TOP-ADJ 1-TRN	73138	82PRS0
A3R24	0757-0442	9	2	RESISTOR 10K 1% .125W F TC=0+-100	24546	C4-1/8-T0-1002-F
A3R25	0757-0438	3	6	RESISTOR 5.11K 1% .125W F TC=0+-100	24546	C4-1/8-T0-5111-F
A3R26	2100-2633	5	1	RESISTOR-TRMR 1+ 10% C SIDE-ADJ 1-TRN	30983	ET50X102
A3R27	0757-0401	0		RESISTOR 100 1% .125W F TC=0+-100	24546	C4-1/8-T0-101-F
A3R28	0757-0442	9		RESISTOR 10K 1% .125W F TC=0+-100	24546	C4-1/8-T0-1002-F
A3R29	0757-0463	4	1	RESISTOR 82.5K 1% .125W F TC=0+-100	24546	C4-1/8-T0-8252-F
A3R30	0698-3449	6		RESISTOR 28.7K 1% .125W F TC=0+-100	24546	C4-1/8-T0-2872-F
A3R31	0757-0278	9	2	RESISTOR 1.78K 1% .125W F TC=0+-100	24546	C4-1/8-T0-1781-F
A3R32	0698-3432	7	1	RESISTOR 26.1 1% .125W F TC=0+-100	03888	PN655-1/8-T0-26R1-F
A3R33	0698-3150	6	3	RESISTOR 2.37K 1% .125W F TC=0+-100	24546	C4-1/8-T0-2371-F
A3R34	0757-0461	2	1	RESISTOR 68.1K 1% .125W F TC=0+-100	24546	C4-1/8-T0-6812-F
A3R35	0698-3449	6		RESISTOR 28.7K 1% .125W F TC=0+-100	24546	C4-1/8-T0-2872-F
A3R36	0698-3150	6		RESISTOR 2.37K 1% .125W F TC=0+-100	24546	C4-1/8-T0-2371-F
A3R37	0757-0424	7	1	RESISTOR 1.1K 1% .125W F TC=0+-100	24546	C4-1/8-T0-1101-F
A3R38	0757-0346	2		RESISTOR 10 1% .125W F TC=0+-100	24546	C4-1/8-T0-10R0-F
A3R39	0757-0346	2		RESISTOR 10 1% .125W F TC=0+-100	24546	C4-1/8-T0-10R0-F
A3R40	0757-0438	3		RESISTOR 5.11K 1% .125W F TC=0+-100	24546	C4-1/8-T0-5111-F
A3R41	0757-0280	3		RESISTOR 1K 1% .125W F TC=0+-100	24546	C4-1/8-T0-1001-F
A3R42	0757-0401	0		RESISTOR 100 1% .125W F TC=0+-100	24546	C4-1/8-T0-101-F
A3R43	0757-0280	3		RESISTOR 1K 1% .125W F TC=0+-100	24546	C4-1/8-T0-1001-F
A3R44	0757-0280	3		RESISTOR 1K 1% .125W F TC=0+-100	24546	C4-1/8-T0-1001-F
A3R45	0757-0419	0	1	RESISTOR 681 1% .125W F TC=0+-100	24546	C4-1/8-T0-681R-F
A3R46	0757-0401	0		RESISTOR 100 1% .125W F TC=0+-100	24546	C4-1/8-T0-101-F
A3R47	2100-2413	9		RESISTOR-TRMR 200 10% C SIDE-ADJ 1-TRN	30983	ET50X201
A3R48	0757-0399	5	1	RESISTOR 82.5 1% .125W F TC=0+-100	24546	C4-1/8-T0-82R5-F
A3R49	0698-0083	8	2	RESISTOR 1.96K 1% .125W F TC=0+-100	24546	C4-1/8-T0-1961-F
A3R50	0698-0083	8		RESISTOR 1.96K 1% .125W F TC=0+-100	24546	C4-1/8-T0-1961-F
A3R51	0757-0438	3		RESISTOR 5.11K 1% .125W F TC=0+-100	24546	C4-1/8-T0-5111-F
A3R52	0757-0438	3		RESISTOR 5.11K 1% .125W F TC=0+-100	24546	C4-1/8-T0-5111-F
A3R53	0757-0438	3		RESISTOR 5.11K 1% .125W F TC=0+-100	24546	C4-1/8-T0-5111-F
A3R54	2100-2489	9		RESISTOR-TRMR 5K 10% C SIDE-ADJ 1-TRN	30983	ET50X502
A3R55	0698-3150	6		RESISTOR 2.37K 1% .125W F TC=0+-100	24546	C4-1/8-T0-2371-F
A3R56	0757-0438	3		RESISTOR 5.11K 1% .125W F TC=0+-100	24546	C4-1/8-T0-5111-F
A3R57	0757-0422	5	1	RESISTOR 909 1% .125W F TC=0+-100	24546	C4-1/8-T0-909R-F
A3R58	0698-3157	3		RESISTOR 19.6K 1% .125W F TC=0+-100	24546	C4-1/8-T0-1962-F
A3R59	0757-0278	9		RESISTOR 1.78K 1% .125W F TC=0+-100	24546	C4-1/8-T0-1781-F
A3R60	0757-0394	0	2	RESISTOR 51.1 1% .125W F TC=0+-100	24546	C4-1/8-T0-51R1-F
A3R61	0757-0402	1	1	RESISTOR 110 1% .125W F TC=0+-100	24546	C4-1/8-T0-111-F
A3R62	0757-0401	0		RESISTOR 100 1% .125W F TC=0+-100	24546	C4-1/8-T0-101-F
A3R63	0757-0401	0		RESISTOR 100 1% .125W F TC=0+-100	24546	C4-1/8-T0-101-F
A3RT1	0839-0011	2	1	THERMISTOR DISC 100-OHM TC=-3.8%/C-DEG	28480	0839-0011
A3TP1	1251-0600	0		CONNECTOR-SGL CONT PIN 1.14-MM-BSC-SZ SQ	28480	1251-0600
A3TP2	1251-0600	0		CONNECTOR-SGL CONT PIN 1.14-MM-BSC-SZ SQ	28480	1251-0600
A3TP3	1251-0600	0		CONNECTOR-SGL CONT PIN 1.14-MM-BSC-SZ SQ	28480	1251-0600
A3TP4	1251-0600	0		CONNECTOR-SGL CONT PIN 1.14-MM-BSC-SZ SQ	28480	1251-0600
A3TP5	1251-0600	0		CONNECTOR-SGL CONT PIN 1.14-MM-BSC-SZ SQ	28480	1251-0600

See introduction to this section for ordering information

Table 6-2. Replaceable Parts

Reference Designation	HP Part Number	C D	Qty	Description	Mfr Code	Mfr Part Number
A3TP6	1251-0600	0		CONNECTOR-SGL CONT PIN 1.14-MM-BSC-SZ SQ	28480	1251-0600
A3TP7	1251-0600	0		CONNECTOR-SGL CONT PIN 1.14-MM-BSC-SZ SQ	28480	1251-0600
A3TP8	1251-0600	0		CONNECTOR-SGL CONT PIN 1.14-MM-BSC-SZ SQ	28480	1251-0600
A3TP9	1251-0600	0		CONNECTOR-SGL CONT PIN 1.14-MM-BSC-SZ SQ	28480	1251-0600
A3TP10	1251-0600	0		CONNECTOR-SGL CONT PIN 1.14-MM-BSC-SZ SQ	28480	1251-0600
A3TP11	1251-0600	0		CONNECTOR-SGL CONT PIN 1.14-MM-BSC-SZ SQ	28480	1251-0600
A3TP12	1251-0600	0		CONNECTOR-SGL CONT PIN 1.14-MM-BSC-SZ SQ	28480	1251-0600
A3TP13	1251-0600	0		CONNECTOR-SGL CONT PIN 1.14-MM-BSC-SZ SQ	28480	1251-0600
A3U1	1826-0026	3	1	IC COMPARATOR PRCN TO-99 PKG	01295	LM311L
A3U2	1826-0025	2	1	IC OP AMP LOW-DRIFT TO-99 PKG	27014	LM208AH
A3U3	1820-1971	7	1	IC SWITCH ANLG QUAD 16-DIP-P PKG	17856	DG201CJ
A3U4	1820-1282	3	1	IC FF TTL LS J-K BAR POS-EDGE-TRIG	01295	SN74LS109AN
A3U5	1826-0180	0	1	IC TIMER TTL MOND/ASTBL	01295	NE555P
A3U6	1826-0217	4	1	IC OP AMP GP DUAL TO-99 PKG	07933	RC4558T
A3U7	1826-0215	2	1	IC V RGLTR-FXD-NEG 5/5.4V TO-220 PKG	28480	1826-0215
A3U8	1826-0122	0	1	IC 7805 V RGLTR TO-220	07263	7805UC
A3XA2	1251-0472	4	1	CONNECTOR-PC EDGE 6-CONT/ROW 2-ROWS	28480	1251-0472
A4	0960-0443	1	1	MODULE ASSEMBLY-POWER LINE (ORDER C1 WITH A4)	28480	0960-0443
A4C1	0160-4851	7	1	CAPACITOR-FXD .022UF +-20% 250VAC(RMS)	28480	0160-4851

See introduction to this section for ordering information

Table 6-2. Replaceable Parts

Reference Designation	HP Part Number	C D	Qty	Description	Mfr Code	Mfr Part Number
CHASSIS PARTS						
F1	2110-0234	9	1	FUSE .1A 250V TD 1.25X.25 UL (FOR 200 TO 240V AC INPUT)	71400	MDL 1/10,
F1	2110-0320	4	1	FUSE .15A 250V TD 1.25X.25 UL (FOR 100 TO 120V AC INPUT)	75915	313.150
J1	1251-1864	0	1	CONNECTOR 5-PIN F CIRC AUDIO	28480	1251-1864
J2	1250-0083	1	3	CONNECTOR-RF BNC FEM SGL-HOLE-FR 50-OHM	28480	1250-0083
J3	1250-0083	1	1	CONNECTOR-RF BNC FEM SGL-HOLE-FR 50-OHM	28480	1250-0083
J4	1250-0083	1	1	CONNECTOR-RF BNC FEM SGL-HOLE-FR 50-OHM	28480	1250-0083
J5	1251-0087	7	1	CONNECTOR 50-PIN F MICRO RIBBON	28480	1251-0087
M1A1	08900-60230	5	1	LED BOARD ASSEMBLY	28480	08900-60230
M1A1DS1				NOT ASSIGNED		
M1A1DS2				NOT ASSIGNED		
M1A1DS3				NOT ASSIGNED		
M1A1DS4				NOT ASSIGNED		
M1A1DS5	1990-0776	7	1	LED-LIGHT BAR MODULE LUM-INT=3MCD	28480	HLMP-2600
M1A1DS6	1990-0759	6	1	LED-LIGHT BAR MODULE LUM-INT=3MCD	28480	HLMP-2620
M1A1DS7	1990-0869	9	1	DISPLAY-SOL-STA RED	28480	1990-0869
M1A1J1	1251-0600	0		CONNECTOR-SGL CONT PIN 1.14-MM-BSC-SZ SQ	28480	1251-0600
M1A1P1	1251-5769	2	1	CONNECTOR 30-PIN F POST TYPE	28480	1251-5769
M1A1P2	1251-5770	5	1	CONNECTOR 18-PIN F POST TYPE	28480	1251-5770
M1A1R1	0757-0395	1	1	RESISTOR 56.2 1% .125W F TC=0+-100	24546	C4-1/8-T0-56R2-F
M1A2	00432-60114	1	1	A/D BOARD ASSEMBLY	28480	00432-60114
M1A2C1	0140-0193	0	1	CAPACITOR-FXD 82PF +-5% 300VDC MICA	72136	DM15E820J0300UV1CR
M1A2C2	0160-0168	1	1	CAPACITOR-FXD .1UF +-10% 200VDC POLYE	28480	0160-0168
M1A2C3	0160-4084	8	5	CAPACITOR-FXD .1UF +-20% 50VDC CER	28480	0160-4084
M1A2C4	0160-4084	8	8	CAPACITOR-FXD .1UF +-20% 50VDC CER	28480	0160-4084
M1A2C5	0160-4084	8	8	CAPACITOR-FXD .1UF +-20% 50VDC CER	28480	0160-4084
M1A2C6	0160-4084	8		CAPACITOR-FXD .1UF +-20% 50VDC CER	28480	0160-4084
M1A2C7	0160-4084	8		CAPACITOR-FXD .1UF +-20% 50VDC CER	28480	0160-4084
M1A2R1	0698-7273	2	1	RESISTOR 34.8K 1% .05W F TC=0+-100	24546	C3-1/8-T0-3482-F
M1A2R2	0698-7281	2	2	RESISTOR 75K 2% .05W F TC=0+-100	24546	C3-1/8-T0-7502-G
M1A2R3	0698-7281	2	2	RESISTOR 75K 2% .05W F TC=0+-100	24546	C3-1/8-T0-7502-G
M1A2R4	2100-3103	6	1	RESISTOR-TRMR 10K 10% C SIDE-ADJ 17-TRN	02111	43P103
M1A2R5	0698-3260	9	1	RESISTOR 464K 1% .125W F TC=0+-100	28480	0698-3260
M1A2R6	2100-2522	1	1	RESISTOR-TRMR 10K 10% C SIDE-ADJ 1-TRN	30983	ET50X103
M1A2R7	0757-0394	0		RESISTOR 51.1 1% .125W F TC=0+-100	24546	C4-1/8-T0-51R1-F
M1A2R8	0698-3429	2	8	RESISTOR 19.6 1% .125W F TC=0+-100	03888	PME55-1/8-T0-19R6-F
M1A2R9	0698-3429	2		RESISTOR 19.6 1% .125W F TC=0+-100	03888	PME55-1/8-T0-19R6-F
M1A2R10	0698-3429	2		RESISTOR 19.6 1% .125W F TC=0+-100	03888	PME55-1/8-T0-19R6-F
M1A2R11	0698-3429	2		RESISTOR 19.6 1% .125W F TC=0+-100	03888	PME55-1/8-T0-19R6-F
M1A2R12	0698-3429	2		RESISTOR 19.6 1% .125W F TC=0+-100	03888	PME55-1/8-T0-19R6-F
M1A2R13	0698-3429	2		RESISTOR 19.6 1% .125W F TC=0+-100	03888	PME55-1/8-T0-19R6-F
M1A2R14	0698-3429	2		RESISTOR 19.6 1% .125W F TC=0+-100	03888	PME55-1/8-T0-19R6-F
M1A2R15	0698-3429	2		RESISTOR 19.6 1% .125W F TC=0+-100	03888	PME55-1/8-T0-19R6-F
M1A2TP1	1251-0600	0		CONNECTOR-SGL CONT PIN 1.14-MM-BSC-SZ SQ	28480	1251-0600
M1A2TP2	1251-0600	0		CONNECTOR-SGL CONT PIN 1.14-MM-BSC-SZ SQ	28480	1251-0600
M1A2U1	1826-0431	4	1	IC CONV 24-DIP-C PKG	04713	MC14433L
M1A2U2	1820-1413	2	1	IC DCDR CMOS BCD-T0-7-SEG 4-T0-7-LINE	3L585	CD4511BE
M1A2U3	1820-1317	5	1	IC MV CMOS MONO/ASTBL	3L585	CD4047AE
M1A2U4	1820-1964	8	1	IC FF CMOS J-K POS-EDGE-TRIG DUAL	3L585	CD4027BE
M1A2U5	1820-1657	6	1	IC GATE CMOS HEX	04713	MC14572UBCP
M1A2U6	1826-0013	8		IC OP AMP LOW-NOISE T0-99 PKG	06665	SSS741CJ
M1A2U7	1820-1747	5	1	IC GATE CMOS NAND QUAD 2-INP	04713	MC14011BCP
M1A2U8	1820-2273	4	1	IC DRVR TTL OCTL	13606	UDN2981A
M1A2U9	1858-0069	1	1	TRANSISTOR ARRAY 18-PIN PLSTC DIP	13606	ULN-2803A
M1A2U10	1820-1146	8	4	IC BFR CMOS NON-INV HEX	3L585	CD4050BE

See introduction to this section for ordering information



Table 6-2. Replaceable Parts

Reference Designation	HP Part Number	C D	Qty	Description	Mfr Code	Mfr Part Number
M1A2U11	1826-0544	0	1	IC V RGLTR-V-REF-FXD 2.5V 8-DIP-C PKG	28480	1826-0544
M1A3	00432-60115	2	1	BCD DMUX BOARD ASSEMBLY	28480	00432-60115
M1A3C1	0180-0094	4	1	CAPACITOR-FXD 100UF+75-10% 25VDC AL	56289	30D107G025DD2
M1A3C2	0180-2154	1	1	CAPACITOR-FXD 1900UF+75-10% 15VDC AL	28480	0180-2154
M1A3C3	0180-0291	3	1	CAPACITOR-FXD 1UF+-10% 35VDC TA	56289	150D105X9035A2
M1A3C4	0160-0576	5		CAPACITOR-FXD .1UF +-20% 50VDC CER	28480	0160-0576
M1A3C5	0160-0576	5		CAPACITOR-FXD .1UF +-20% 50VDC CER	28480	0160-0576
M1A3C6	0160-0576	5		CAPACITOR-FXD .1UF +-20% 50VDC CER	28480	0160-0576
M1A3C7	0160-0576	5		CAPACITOR-FXD .1UF +-20% 50VDC CER	28480	0160-0576
M1A3CR1	1901-0328	8	4	DIODE-PWR RECT 400V 1A 6US	03508	A14D
M1A3CR2	1901-0328	8		DIODE-PWR RECT 400V 1A 6US	03508	A14D
M1A3CR3	1901-0328	8		DIODE-PWR RECT 400V 1A 6US	03508	A14D
M1A3CR4	1901-0328	8		DIODE-PWR RECT 400V 1A 6US	03508	A14D
M1A3CR5	1902-0579	3	1	DIODE-ZNR 5.1V 5% PD=1W IR=10UA	28480	1902-0579
M1A3J1	1251-0600	0		CONNECTOR-SGL CONT PIN 1.14-MM-BSC-SZ SQ	28480	1251-0600
M1A3J2	1251-0600	0		CONNECTOR-SGL CONT PIN 1.14-MM-BSC-SZ SQ	28480	1251-0600
M1A3J3	1251-0600	0		CONNECTOR-SGL CONT PIN 1.14-MM-BSC-SZ SQ	28480	1251-0600
M1A3MP1	1400-0016	9	1	CLAMP-CABLE .75-DIA .5-WD NYL	28480	1400-0016
M1A3MP2	2200-0147	4	1	SCREW-MACH 4-40 .5-IN-LG PAN-HD-POZI	28480	2200-0147
M1A3MP3	2260-0009	3		NUT-HEX-W/LKWR 4-40-THD .094-IN-THK	00000	ORDER BY DESCRIPTION
M1A3MP4	3050-0105	6		WASHER-FL MTLIC NO. 4 .125-IN-ID	28480	3050-0105
M1A3Q1	1854-0477	7		TRANSISTOR NPN 2N2222A SI TO-18 PD=500MW	04713	2N2222A
M1A3R1	0698-3441	8		RESISTOR 215 1% .125W F TC=0+-100	24546	C4-1/8-T0-215R-F
M1A3R2				NOT ASSIGNED		
M1A3R3	0698-7244	7	2	RESISTOR 2.15K 1% .05W F TC=0+-100	24546	C3-1/8-T0-2151-F
M1A3R4	0698-7244	7		RESISTOR 2.15K 1% .05W F TC=0+-100	24546	C3-1/8-T0-2151-F
M1A3R5	0698-7240	3	1	RESISTOR 1.47K 1% .05W F TC=0+-100	24546	C3-1/8-T0-1471-F
M1A3TP1	1251-0600	0		CONNECTOR-SGL CONT PIN 1.14-MM-BSC-SZ SQ	28480	1251-0600
M1A3U1	1820-1956	8	4	IC LCH CMOS COM CLOCK QUAD	3L585	CD4042BE
M1A3U2	1820-1956	8		IC LCH CMOS COM CLOCK QUAD	3L585	CD4042BE
M1A3U3	1820-1956	8		IC LCH CMOS COM CLOCK QUAD	3L585	CD4042BE
M1A3U4	1820-1956	8		IC LCH CMOS COM CLOCK QUAD	3L585	CD4042BE
M1A3U5	1820-1146	8		IC BFR CMOS NON-INV HEX	3L585	CD4050BE
M1A3U6	1820-1146	8		IC BFR CMOS NON-INV HEX	3L585	CD4050BE
M1A3U7	1820-1146	8		IC BFR CMOS NON-INV HEX	3L585	CD4050BE
M1A3U8	1820-1461	0	2	IC FF TTL D-TYPE POS-EDGE-TRIG CLEAR	01295	SN74273
M1A3U9	1820-1461	0		IC FF TTL D-TYPE POS-EDGE-TRIG CLEAR	01295	SN74273
M1A3U10	1820-0084	1	1	IC GATE TTL AND-OR-INV	01295	SN7453N
XM1A1DS1	1200-0508	0	4	SOCKET-IC 14-CONT DIP-SLDR	28480	1200-0508
XM1A1DS2	1200-0508	0		SOCKET-IC 14-CONT DIP-SLDR	28480	1200-0508
XM1A1DS3	1200-0508	0		SOCKET-IC 14-CONT DIP-SLDR	28480	1200-0508
XM1A1DS4	1200-0508	0		SOCKET-IC 14-CONT DIP-SLDR	28480	1200-0508
XM1A1DS5	1200-0564	8	1	SOCKET-IC 8-CONT DIP-SLDR	28480	1200-0564
XM1A1DS6	1200-0507	9	1	SOCKET-IC 16-CONT DIP-SLDR	28480	1200-0507
XM1A1P1	1251-5771	6	1	CONNECTOR 30-PIN M POST TYPE	28480	1251-5771
XM1A1P2	1251-5772	7	1	CONNECTOR 18-PIN M POST TYPE	28480	1251-5772
XM1A2	1251-0159	4	2	CONNECTOR-PC EDGE 15-CONT/ROW 2-ROWS P/O MP154	28480	1251-0159
XM1A3	1251-0159	4		CONNECTOR-PC EDGE 15-CONT/ROW 2-ROWS P/O MP154	28480	1251-0159

See introduction to this section for ordering information

Table 6-2. Replaceable Parts

Reference Designation	HP Part Number	C D	Qty	Description	Mfr Code	Mfr Part Number
MP1	0360-0001	5	2	TERMINAL-SLDR LUG LK-MTG FOR-#6-SCR	28480	0360-0001
MP2	0360-0001	5		TERMINAL-SLDR LUG LK-MTG FOR-#6-SCR	28480	0360-0001
MP3	0360-0353	0	4	BRACKET-RTANG .406-LG X .343-LG .312-WD	28480	0360-0353
MP4	0360-0353	0		BRACKET-RTANG .406-LG X .343-LG .312-WD	28480	0360-0353
MP5	0360-0353	0		BRACKET-RTANG .406-LG X .343-LG .312-WD	28480	0360-0353
MP6	0360-0353	0		BRACKET-RTANG .406-LG X .343-LG .312-WD	28480	0360-0353
MP7	0362-0227	1	16	CONNECTOR-SGL CONT SKT 1.14-MM-BSC-SZ	28480	0362-0227
MP8	0362-0227	1		CONNECTOR-SGL CONT SKT 1.14-MM-BSC-SZ	28480	0362-0227
MP9	0362-0227	1		CONNECTOR-SGL CONT SKT 1.14-MM-BSC-SZ	28480	0362-0227
MP10	0362-0227	1		CONNECTOR-SGL CONT SKT 1.14-MM-BSC-SZ	28480	0362-0227
MP11	0362-0227	1		CONNECTOR-SGL CONT SKT 1.14-MM-BSC-SZ	28480	0362-0227
MP12	0362-0227	1		CONNECTOR-SGL CONT SKT 1.14-MM-BSC-SZ	28480	0362-0227
MP13	0362-0227	1		CONNECTOR-SGL CONT SKT 1.14-MM-BSC-SZ	28480	0362-0227
MP14	0362-0227	1		CONNECTOR-SGL CONT SKT 1.14-MM-BSC-SZ	28480	0362-0227
MP15	0362-0227	1		CONNECTOR-SGL CONT SKT 1.14-MM-BSC-SZ	28480	0362-0227
MP16	0370-1091	6	1	KNOB-BASE 1/2 JGK .25-IN-ID	28480	0370-1091
MP17				NOT ASSIGNED		
MP18				NOT ASSIGNED		
MP19				NOT ASSIGNED		
MP20				NOT ASSIGNED		
MP21	0590-0052	3	2	NUT-SHMET-J-TP 6-32-THD .5 WD STL	28480	0590-0052
MP22	0590-0052	3		NUT-SHMET-J-TP 6-32-THD .5-WD STL	28480	0590-0052
MP23	1490-0031	7	1	TILT STAND 2.236-IN-W 4.438-IN-OA-LG SST	28480	1490-0031
MP24				NOT ASSIGNED		
MP25	2190-0003	8	2	WASHER-LK HLCL NO. 4 .115-IN-ID	28480	2190-0003
MP26	2190-0003	8		WASHER-LK HLCL NO. 4 .115-IN-ID	28480	2190-0003
MP27	2190-0016	3	4	WASHER-LK INTL T 3/8 IN .377-IN-ID	28480	2190-0016
MP28	2190-0016	3		WASHER-LK INTL T 3/8 IN .377-IN-ID	28480	2190-0016
MP29	2190-0016	3		WASHER-LK INTL T 3/8 IN .377-IN-ID	28480	2190-0016
MP30	2190-0016	3		WASHER-LK INTL T 3/8 IN .377-IN-ID	28480	2190-0016
MP31				NOT ASSIGNED		
MP32	2190-0017	4	2	WASHER-LK HLCL NO. 8 .168-IN-ID	28480	2190-0017
MP33	2190-0017	4		WASHER-LK HLCL NO. 8 .168-IN-ID	28480	2190-0017
MP34	2190-0047	0	4	WASHER-LK 82 CTSK EXT T NO. 6 .142-IN-ID	28480	2190-0047
MP35	2190-0047	0		WASHER-LK 82 CTSK EXT T NO. 6 .142-IN-ID	28480	2190-0047
MP36	2190-0047	0		WASHER-LK 82 CTSK EXT T NO. 6 .142-IN-ID	28480	2190-0047
MP37	2190-0047	0		WASHER-LK 82 CTSK EXT T NO. 6 .142-IN-ID	28480	2190-0047
MP38	2260-0002	6	2	NUT-HEX-DBL-CHAM 4-40-THD .062-IN-THK	28480	2260-0002
MP39	2260-0002	6		NUT-HEX-DBL-CHAM 4-40-THD .062-IN-THK	28480	2260-0002
MP40	2360-0116	5	12	SCREW-MACH 6-32 .312-IN-LG 82 DEG	00000	ORDER BY DESCRIPTION
MP41	2360-0116	5		SCREW-MACH 6-32 .312-IN-LG 82 DEG	00000	ORDER BY DESCRIPTION
MP42	2360-0116	5		SCREW-MACH 6-32 .312-IN-LG 82 DEG	00000	ORDER BY DESCRIPTION
MP43	2360-0116	5		SCREW-MACH 6-32 .312-IN-LG 82 DEG	00000	ORDER BY DESCRIPTION
MP44	2360-0116	5		SCREW-MACH 6-32 .312-IN-LG 82 DEG	00000	ORDER BY DESCRIPTION
MP45	2360-0116	5		SCREW-MACH 6-32 .312-IN-LG 82 DEG	00000	ORDER BY DESCRIPTION
MP46	2360-0116	5		SCREW-MACH 6-32 .312-IN-LG 82 DEG	00000	ORDER BY DESCRIPTION
MP47	2360-0116	5		SCREW-MACH 6-32 .312-IN-LG 82 DEG	00000	ORDER BY DESCRIPTION
MP48	2360-0116	5		SCREW-MACH 6-32 .312-IN-LG 82 DEG	00000	ORDER BY DESCRIPTION
MP49	2360-0116	5		SCREW-MACH 6-32 .312-IN-LG 82 DEG	00000	ORDER BY DESCRIPTION
MP50	2360-0116	5		SCREW-MACH 6-32 .312-IN-LG 82 DEG	00000	ORDER BY DESCRIPTION
MP51	2360-0116	5		SCREW-MACH 6-32 .312-IN-LG 82 DEG	00000	ORDER BY DESCRIPTION
MP52				NOT ASSIGNED		
MP53	2360-0117	6	7	SCREW-MACH 6-32 .375-IN-LG PAN-HD-POZI	00000	ORDER BY DESCRIPTION
MP54	2360-0117	6		SCREW-MACH 6-32 .375-IN-LG PAN-HD-POZI	00000	ORDER BY DESCRIPTION
MP55	2360-0117	6		SCREW-MACH 6-32 .375-IN-LG PAN-HD-POZI	00000	ORDER BY DESCRIPTION
MP56	2360-0117	6		SCREW-MACH 6-32 .375-IN-LG PAN-HD-POZI	00000	ORDER BY DESCRIPTION
MP57	2360-0120	1	4	SCREW-MACH 6-32 .438-IN-LG 82 DEG	00000	ORDER BY DESCRIPTION
MP58	2360-0120	1		SCREW-MACH 6-32 .438-IN-LG 82 DEG	00000	ORDER BY DESCRIPTION
MP59	2360-0120	1		SCREW-MACH 6-32 .438-IN-LG 82 DEG	00000	ORDER BY DESCRIPTION
MP60	2360-0120	1		SCREW-MACH 6-32 .438-IN-LG 82 DEG	00000	ORDER BY DESCRIPTION
MP61				NOT ASSIGNED		
MP62	2360-0180	3	4	SCREW-MACH 6-32 .188-IN-LG 82 DEG	00000	ORDER BY DESCRIPTION
MP63	2360-0180	3		SCREW-MACH 6-32 .188-IN-LG 82 DEG	00000	ORDER BY DESCRIPTION
MP64	2360-0180	3		SCREW-MACH 6-32 .188-IN-LG 82 DEG	00000	ORDER BY DESCRIPTION
MP65	2360-0180	3		SCREW-MACH 6-32 .188-IN-LG 82 DEG	00000	ORDER BY DESCRIPTION

See introduction to this section for ordering information

Table 6-2. Replaceable Parts

Reference Designation	HP Part Number	C D	Qty	Description	Mfr Code	Mfr Part Number
MP66	2360-0192	7	8	SCREW-MACH 6-32 .25-IN-LG 100 DEG	28480	2360-0192
MP67	2360-0192	7		SCREW-MACH 6-32 .25-IN-LG 100 DEG	28480	2360-0192
MP68	2360-0192	7		SCREW-MACH 6-32 .25-IN-LG 100 DEG	28480	2360-0192
MP69	2360-0192	7		SCREW-MACH 6-32 .25-IN-LG 100 DEG	28480	2360-0192
MP70	2360-0192	7		SCREW-MACH 6-32 .25-IN-LG 100 DEG	28480	2360-0192
MP71	2360-0192	7	2	SCREW-MACH 6-32 .25-IN-LG 100 DEG	28480	2360-0192
MP72	2360-0192	7		SCREW-MACH 6-32 .25-IN-LG 100 DEG	28480	2360-0192
MP73	2360-0192	7		SCREW-MACH 6-32 .25-IN-LG 100 DEG	28480	2360-0192
MP74	2360-0194	9		SCREW-MACH 6-32 .312-IN-LG 100 DEG	00000	ORDER BY DESCRIPTION
MP75	2360-0194	9		SCREW-MACH 6-32 .312-IN-LG 100 DEG	00000	ORDER BY DESCRIPTION
MP76	2420-0002	6	4	NUT-HEX-DBL-CHAM 6-32-THD .109-IN-THK	28480	2420-0002
MP77	2420-0002	6		NUT-HEX-DBL-CHAM 6-32-THD .109-IN-THK	28480	2420-0002
MP78	2510-0103	9	2	SCREW-MACH 8-32 .375-IN-LG PAN-HD-POZI	28480	2510-0103
MP79	2510-0103	9		SCREW-MACH 8-32 .375-IN-LG PAN-HD-POZI	28480	2510-0103
MP80	2580-0002	4	2	NUT-HEX-DBL-CHAM 8-32-THD .085-IN-THK	28480	2580-0002
MP81	2580-0002	4	3	NUT-HEX-DBL-CHAM 8-32-THD .085-IN-THK	28480	2580-0002
MP82	2950-0001	8		NUT-HEX-DBL-CHAM 3/8-32-THD .094-IN-THK	00000	ORDER BY DESCRIPTION
MP83	2950-0001	8		NUT-HEX-DBL-CHAM 3/8-32-THD .094-IN-THK	00000	ORDER BY DESCRIPTION
MP84	2950-0001	8		NUT-HEX-DBL-CHAM 3/8-32-THD .094-IN-THK	00000	ORDER BY DESCRIPTION
MP85	2950-0043	8		NUT-HEX-DBL-CHAM 3/8-32-THD .094-IN-THK	00000	ORDER BY DESCRIPTION
MP86	3030-0139	4	4	SCREW-SKT HD CAP 6-32 .375-IN-LG SST	00000	ORDER BY DESCRIPTION
MP87	3030-0139	4		SCREW-SKT HD CAP 6-32 .375-IN-LG SST	00000	ORDER BY DESCRIPTION
MP88	3050-0227	3	4	WASHER-FL MTLG NO. 6 .149-IN-ID	28480	3050-0227
MP89	7120-1254	1		NAMEPLATE .312-IN-WD .54-IN-LG AL	28480	7120-1254
MP90	7120-4163	7	1	LABEL-WARNING .5-IN-WD 1-IN-LG AL	28480	7120-4163
MP91	5000-8565	5	2	COVER-SIDE 6 X 11	28480	5000-8565
MP92	5000-8565	5		COVER-SIDE 6 X 11	28480	5000-8565
MP93	5000-8571	3	1	COVER-BOTTOM 5 X 11	28480	5000-8571
MP94				NOT ASSIGNED		
MP95	5020-7633	8	1	METER TRIM-3RD MODULE	28480	5020-7633
MP96	5040-0700	8	2	HINGE	28480	5040-0700
MP97	5040-0700	8		HINGE	28480	5040-0700
MP98				NOT ASSIGNED		
MP99	5060-0703	3	2	FRAME ASSY- 6 X 11 SM	28480	5060-0703
MP100	5060-0703	3		FRAME ASSY- 6 X 11 SM	28480	5060-0703
MP101	5060-0727	1	2	FOOT ASSEMBLY-3RD MODULE	28480	5060-0727
MP102	5060-0727	1		FOOT ASSEMBLY-3RD MODULE	28480	5060-0727
MP103	5060-8555	9	1	COVER ASSEMBLY- (TOP) 5 X 11	28480	5060-8555
MP104				NOT ASSIGNED		
MP105				NOT ASSIGNED		
MP106				NOT ASSIGNED		
MP107	1400-0017	0	3	CLAMP-CABLE .312-DIA .375-WD NYL	28480	1400-0017
MP108	1400-0249	0		CABLE TIE .062-.625-DIA .091-WD NYL	06383	PLT11M-8
MP109	0360-0042	4	1	TERMINAL-SLDR LUG PL-MTG FOR-#6-SCR	28480	0360-0042
MP110	0360-0268	6		TERMINAL-SLDR LUG LK-MTG FOR-#6-SCR	28480	0360-0268
MP111	0362-0227	1	5	CONNECTOR-SGL CONT SKT 1.14-MM-BSC-SZ	28480	0362-0227
MP112	0362-0227	1		CONNECTOR-SGL CONT SKT 1.14-MM-BSC-SZ	28480	0362-0227
MP113	0362-0227	1		CONNECTOR-SGL CONT SKT 1.14-MM-BSC-SZ	28480	0362-0227
MP114	0362-0227	1		CONNECTOR-SGL CONT SKT 1.14-MM-BSC-SZ	28480	0362-0227
MP115	0362-0227	1		CONNECTOR-SGL CONT SKT 1.14-MM-BSC-SZ	28480	0362-0227
MP116	0362-0227	1	5	CONNECTOR-SGL CONT SKT 1.14-MM-BSC-SZ	28480	0362-0227
MP117	0362-0227	1		CONNECTOR-SGL CONT SKT 1.14-MM-BSC-SZ	28480	0362-0227
MP118	0362-0265	7		CONNECTOR-SGL CONT SKT 1.14-MM-BSC-SZ	28480	0362-0265
MP119	0362-0265	7		CONNECTOR-SGL CONT SKT 1.14-MM-BSC-SZ	28480	0362-0265
MP120	0362-0265	7		CONNECTOR-SGL CONT SKT 1.14-MM-BSC-SZ	28480	0362-0265
MP121	0362-0265	7	7	CONNECTOR-SGL CONT SKT 1.14-MM-BSC-SZ	28480	0362-0265
MP122	0362-0265	7		CONNECTOR-SGL CONT SKT 1.14-MM-BSC-SZ	28480	0362-0265
MP123	0520-0133	4	2	SCREW-MACH 2-56 .5-IN-LG PAN-HD-POZI	00000	ORDER BY DESCRIPTION
MP124	0520-0133	4		SCREW-MACH 2-56 .5-IN-LG PAN-HD-POZI	00000	ORDER BY DESCRIPTION
MP125	0520-0174	3	2	SCREW-MACH 2-56 .25-IN-LG PAN-HD-POZI	00000	ORDER BY DESCRIPTION
MP126	0520-0174	3	3	SCREW-MACH 2-56 .25-IN-LG PAN-HD-POZI	00000	ORDER BY DESCRIPTION
MP127	1400-0017	0		CLAMP-CABLE .312-DIA .375-WD NYL	28480	1400-0017
MP128	1400-0017	0	1	CLAMP-CABLE .312-DIA .375-WD NYL	28480	1400-0017
MP129	1400-0082	9		CLAMP-CABLE .125-DIA .375-WD NYL	28480	1400-0082
MP130	1400-0249	0		CABLE TIE .062-.625-DIA .091-WD NYL	06383	PLT11M-8

See introduction to this section for ordering information

Table 6-2. Replaceable Parts

Reference Designation	HP Part Number	C D	Qty	Description	Mfr Code	Mfr Part Number
MP131	1400-0249	0		CABLE TIE .062-.625-DIA .091-WD NYL	06383	PLT1M-8
MP132	1400-0249	0		CABLE TIE .062-.625-DIA .091-WD NYL	06383	PLT1M-8
MP133	1400-0249	0		CABLE TIE .062-.625-DIA .091-WD NYL	06383	PLT1M-8
MP134	2360-0114	3	7	SCREW-MACH 6-32 .25-IN-LG 82 DEG	00000	ORDER BY DESCRIPTION
MP135	2360-0114	3		SCREW-MACH 6-32 .25-IN-LG 82 DEG	00000	ORDER BY DESCRIPTION
MP136	2360-0114	3		SCREW-MACH 6-32 .25-IN-LG 82 DEG	00000	ORDER BY DESCRIPTION
MP137	2360-0114	3		SCREW-MACH 6-32 .25-IN-LG 82 DEG	00000	ORDER BY DESCRIPTION
MP138	2360-0114	3		SCREW-MACH 6-32 .25-IN-LG 82 DEG	00000	ORDER BY DESCRIPTION
MP139	2360-0114	3		SCREW-MACH 6-32 .25-IN-LG 82 DEG	00000	ORDER BY DESCRIPTION
MP140	2360-0114	3		SCREW-MACH 6-32 .25-IN-LG 82 DEG	00000	ORDER BY DESCRIPTION
MP141	2360-0117	6		SCREW-MACH 6-32 .375-IN-LG PAN-HD-POZI	00000	ORDER BY DESCRIPTION
MP142	2360-0117	6		SCREW-MACH 6-32 .375-IN-LG PAN-HD-POZI	00000	ORDER BY DESCRIPTION
MP143	2360-0117	6		SCREW-MACH 6-32 .375-IN-LG PAN-HD-POZI	00000	ORDER BY DESCRIPTION
MP144	2420-0001	5	2	NUT-HEX-W/LKWR 6-32-THD .109-IN-THK	00000	ORDER BY DESCRIPTION
MP145	2420-0001	5		NUT-HEX-W/LKWR 6-32-THD .109-IN-THK	00000	ORDER BY DESCRIPTION
MP146	3030-0139	4		SCREW-SKT HD CAP 6-32 .375-IN-LG SST	00000	ORDER BY DESCRIPTION
MP147	3030-0139	4		SCREW-SKT HD CAP 6-32 .375-IN-LG SST	00000	ORDER BY DESCRIPTION
MP148	3050-0227	3		WASHER-FL MTLN NO. 6 .149-IN-ID	28480	3050-0227
MP149	3050-0227	3		WASHER-FL MTLN NO. 6 .149-IN-ID	28480	3050-0227
MP150	3050-0227	3		WASHER-FL MTLN NO. 6 .149-IN-ID	28480	3050-0227
MP151	08900-00209	2	1	PANEL-FRONT (D)	28480	08900-00209
MP152	08900-00211	6	1	PANEL-SUB	28480	08900-00211
MP153	08900-00213	8	1	PANEL-REAR (D)	28480	08900-00213
MP154	08900-00214	9	1	BRACKET-DPM ASSY (INCL XM1A2, XM1A3, MP161-164)	28480	08900-00214
MP155	08900-00215	0	1	BRACKET-READOUT	28480	08900-00215
MP156	08900-20232	3	1	WINDOW-FRONT PANEL	28480	08900-20232
MP157	08900-20233	4	1	MASK-DPM	28480	08900-20233
MP158	08900-20234	5	1	BEZEL	28480	08900-20234
MP159	00432-20102	3	2	GUIDE-EXTRUSION	28480	00432-20102
MP160	00432-20102	3		GUIDE-EXTRUSION	28480	00432-20102
MP161	0361-0403	3	4	EYELET-RLD FLG (P/O MP154)	28480	0361-0403
MP162	0361-0403	3		EYELET-RLD FLG (P/O MP154)	28480	0361-0403
MP163	0361-0403	3		EYELET-RLD FLG (P/O MP154)	28480	0361-0403
MP164	0361-0403	3		EYELET-RLD FLG (P/O MP154)	28480	0361-0403
MP165	7120-8968	8	1	TAG-INFORMATION	28480	7120-8968
MP166	2420-0002	6		NUT-HEX-DBL-CHAM 6-32-THD .109-IN-THK	28480	2420-0002
MP167	2420-0002	6		NUT-HEX-DBL-CHAM 6-32-THD .109-IN-THK	28480	2420-0002
R1	2100-2746	1	1	RESISTOR-VAR PREC WW 5-TRN 200 3% (COMPARE LEVEL)	28480	2100-2746
R2				NOT ASSIGNED		
R3	2100-3843	1	1	DIGITAL DISPLAY 100 OHMS +-1%; 2W; 2 (CORRECTION)	28480	2100-3843
T1	9100-0460	9	1	TRANSFORMER-POWER 100/120/220/240V	28480	9100-0460
U1	1826-0181	1	1	IC V RGLTR T0-3	27014	LM323K
W1	8120-1378	1	1	CABLE ASSY 18AWG 3-CNDCT JGK-JKT	28480	8120-1378
W2	08900-60220	3	1	CABLE ASSEMBLY-LINE SWITCH	28480	08900-60220
W2DS1	3131-0434	6	1	LENS ASSY-PUSHBUTTON TRANSLUCENT WHITE	28480	3131-0434
W3	08900-60217	8	1	CABLE ASSEMBLY-(REPLACEMENT) BCD OUTPUT (DOES NOT INCLUDE J5)	28480	08900-60217

See introduction to this section for ordering information

Table 6-3. Code List of Manufacturers

Mfr Code	Manufacturer Name	Address	Zip Code
00000	ANY SATISFACTORY SUPPLIER		
01295	TEXAS INSTR INC SEMICOND CMPNT DIV	DALLAS TX	75222
02111	SPECTROL ELECTRONICS CORP	CITY OF IND CA	91745
03508	GE CO SEMICONDUCTOR PROD DEPT	AUBURN NY	13201
03888	K D I PYROFILM CORP	WHIPPANY NJ	07981
04713	MOTOROLA SEMICONDUCTOR PRODUCTS	PHOENIX AZ	85008
06383	PANDUIT CORP	TINLEY PARK IL	60477
06665	PRECISION MONOLITHICS INC	SANTA CLARA CA	95050
07263	FAIRCHILD SEMICONDUCTOR DIV	MOUNTAIN VIEW CA	94042
07933	RAYTHEON CO SEMICONDUCTOR DIV HQ	MOUNTAIN VIEW CA	94040
13606	SPRAGUE ELECT CO SEMICONDUCTOR DIV	CONCORD NH	03301
17856	SILICONIX INC	SANTA CLARA CA	95054
19701	MEPCO/ELECTRA CORP	MINERAL WELLS TX	76067
24546	CORNING GLASS WORKS (BRADFORD)	BRADFORD PA	16701
25088	SIEMENS CORP	ISELIN NJ	08830
27014	NATIONAL SEMICONDUCTOR CORP	SANTA CLARA CA	95051
28480	HEWLETT-PACKARD CO CORPORATE HQ	PALO ALTO CA	94304
3L585	RCA CORP SOLID STATE DIV	SOMERVILLE NJ	
30983	MEPCO/ELECTRA CORP	SAN DIEGO CA	92121
32997	BOURNS INC TRIMPOT PROD DIV	RIVERSIDE CA	92507
52763	STETTNER ELECTRONICS INC	CHATTANOOGA TN	13035
56289	SPRAGUE ELECTRIC CO	NORTH ADAMS MA	01247
71400	BUSSMAN MFG DIV OF MCGRAW-EDISON CO	ST LOUIS MO	63107
72136	ELECTRO MOTIVE CORP	FLORENCE SC	06226
73138	BECKMAN INSTRUMENTS INC HELIPOT DIV	FULLERTON CA	92634
75915	LITTELFUSE INC	DES PLAINES IL	60016



## **SECTION VII MANUAL CHANGES**

### **7-1. INTRODUCTION**

This section normally contains information for adapting this manual to instruments for which the content does not apply directly. Since this manual does apply directly to instruments having serial

numbers listed on the title page, no change information is given here. Refer to INSTRUMENTS COVERED BY MANUAL in Section I for additional important information about serial number coverage.





## SECTION VIII SERVICE

### WARNINGS

*Any interruption of the protective (grounding) conductor (inside or outside the instrument) or disconnecting the protective earth terminal will cause a potential shock hazard that could result in personal injury. (Grounding one conductor of a two conductor outlet is not sufficient protection). In addition, verify that a common ground exists between the unit under test and this instrument prior to energizing either unit.*

*Whenever it is likely that the protection has been impaired, the instrument must be made inoperative and be secured against any unintended operation.*

*If this instrument is to be energized via an auto-transformer (for voltage reduction), make sure the common terminal is connected to neutral (that is, the grounded side of the mains supply).*

*Servicing instructions are for use by service-trained personnel only. To avoid dangerous electric shock, do not perform any servicing unless qualified to do so.*

*Adjustments described in the manual are performed with power supplied to the instrument while protective covers are removed. Energy available at many points may, if contacted, result in personal injury.*

*Capacitors inside the instrument may still be charged even if the instrument has been disconnected from its source of supply.*

*For continued protection against fire hazard, replace the line fuse(s) only with 250V fuse(s) of the same current rating and type (for example, normal blow, time delay, etc.). Do not use repaired fuses or short circuited fuseholders.*

### 8-1. INTRODUCTION

This section contains instructions for troubleshooting and repairing the Peak Power Meter. It includes principles of operation, troubleshooting informa-

tion, component location photographs, schematics, an illustrated parts breakdown, instrument internal views, and disassembly procedures. The rest of the section has general service information that should help you service and repair the instrument.

### 8-2. PRINCIPLES OF OPERATION

Principles of operation appear on the foldout pages opposite the block diagram and schematics. Figure 8-3 is a block diagram that briefly describes overall instrument operation. It is keyed, by the numbers in the lower, right-hand corners of the blocks, to the schematics on the service sheets that follow. These service sheets provide a stage-by-stage description of the circuits on the schematics. The descriptions are keyed to stage names that appear in brackets on the schematics.

### NOTE

*Figure 8-1 Schematic Diagram Notes, explains most symbols that appear on the schematics.*

### 8-3. TROUBLESHOOTING

#### 8-4. Overall Troubleshooting

The overall block diagram (Figure 8-3) has a set of test conditions to help isolate a problem to a particular service sheet. If the trouble cannot be located using the block diagram, the troubleshooting text should be used to find the problem.

#### 8-5. Circuit-Level Troubleshooting

After a problem has been isolated to an assembly (and corresponding service sheet), the text and table on the service sheet present detailed troubleshooting information for the circuit.

### 8-6. RECOMMENDED TEST EQUIPMENT

Descriptions and critical specifications for equipment are located in the table of Recommended Test Equipment in Section I. Substitute equipment can be used if it meets the minimum critical specifications.

**8-7. SERVICE AIDS**

**8-8. Posidriv Screwdrivers.**

Many screws in the instrument appear to be Phillips, but are not. To avoid damage to the screw slots, Posidriv screwdrivers should be used.

**8-9. Servicing Aids on Printed Circuit Boards.**

The servicing aids include test points, transistor and integrated circuit designations, adjustment callouts and assembly stock numbers.

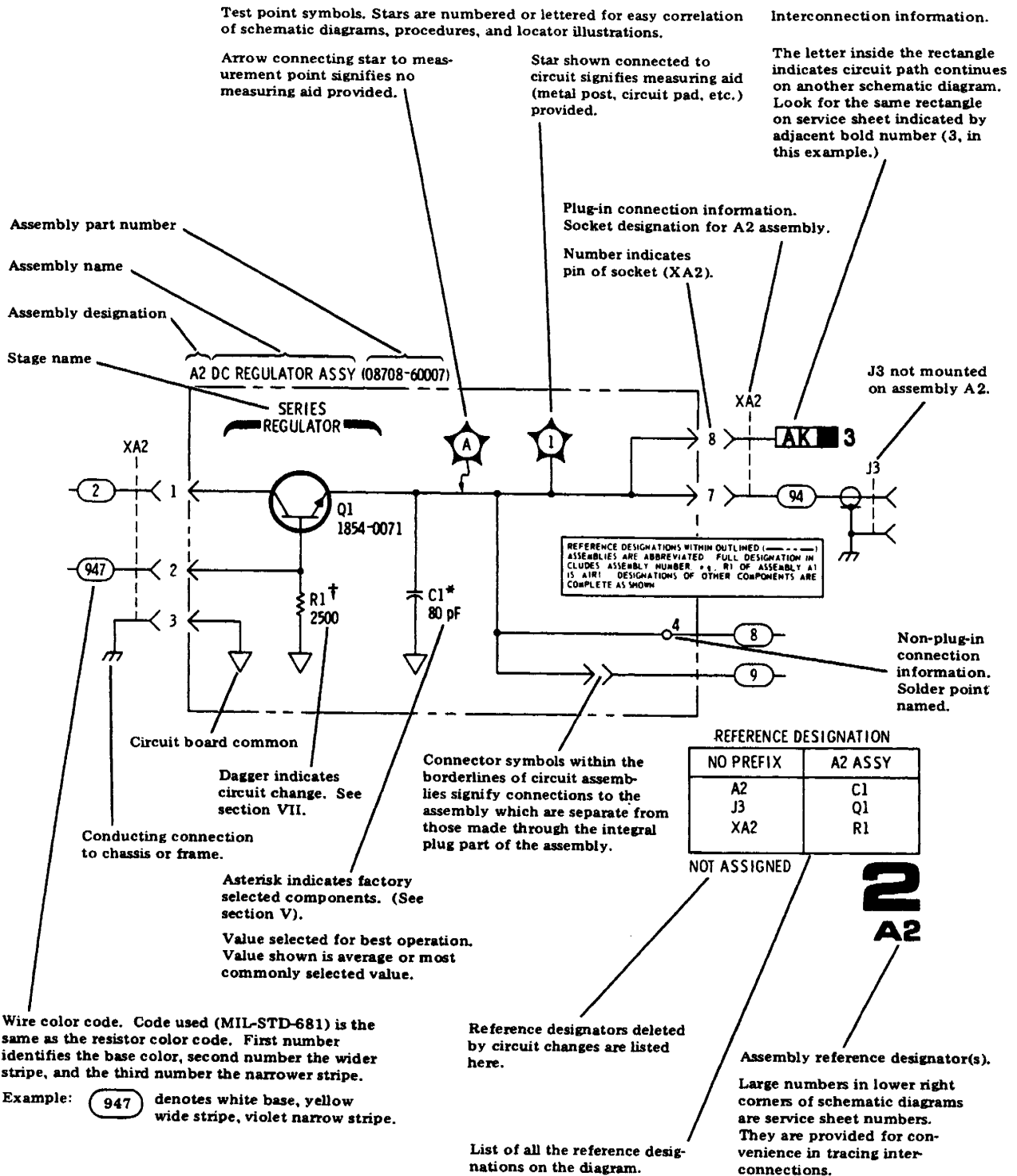



















Figure 8-1. Schematic Diagram Notes (1 of 8)

**SCHEMATIC DIAGRAM NOTES**

*	Asterisk denotes a factory-selected value. Value shown is typical.
†	Dagger indicates circuit change. See Section VII.
	Tool-aided adjustment.
	Manual control.
	Encloses front-panel designation.
	Encloses rear-panel designation.
	Circuit assembly borderline.
	Other assembly borderline.
	Heavy line with arrows indicates path and direction of main signal.
	Heavy dashed line with arrows indicates path and direction of main feedback.
	Indicates stripline (i.e., RF transmission line above ground).
	Wiper moves toward cw with clockwise rotation of control (as viewed from shaft or knob).
	Numbered Test Point measurement aid provided.
	Encloses wire or cable color code. Code used is the same as the resistor color code. First number identifies the base color, second number identifies the wider stripe, and the third number identifies the narrower stripe, e.g., denotes white base, yellow wide stripe, violet narrow stripe.
	A direct conducting connection to earth, or a conducting connection to a structure that has a similar function (e.g., the frame of an air, sea, or land vehicle).
	A conducting connection to a chassis or frame.
	Common connections. All like-designation points are connected.
 12	Letters = off-page connection, e.g., <b>AK</b> Number = Service Sheet number for off-page connection, e.g., <b>12</b>
	Number (only) = on-page connection.

**Figure 8-1. Schematic Diagram Notes (2 of 8)**

**SCHEMATIC DIAGRAM NOTES**

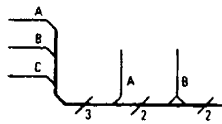

Indicates multiple paths represented by only one line. Letters or names identify individual paths. Numbers indicate number of paths represented by the line.



Coaxial or shielded cable.



Relay. Contact moves in direction of arrow when energized.



Indicates a pushbutton switch with a momentary (ON) position.



Indicates a PIN diode.



Indicates a current regulation diode.



Indicates a voltage regulation diode.



Indicates a Schottky (hot-carrier) diode.

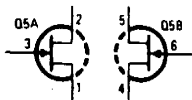

Multiple transistors in a single package—physical location of the pins is shown in package outline on schematic.



Identification of logic families as shown (in this case, ECL).

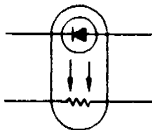

Indicates an opto-isolator of a LED and a photoresistor packaged together. The resistance of the photoresistor is a function of the current flowing through the LED.

**Figure 8-1. Schematic Diagram Notes (3 of 8)**

**DIGITAL SYMBOLOGY REFERENCE INFORMATION**

**Input and Output Indicators**

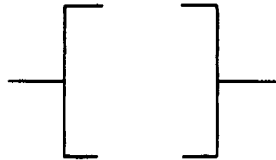

**Implied Indicator**—Absence of polarity indicator (see below) implies that the active state is a relative high voltage level. Absence of negation indicator (see below) implies that the active state is a relative high voltage level at the input or output.

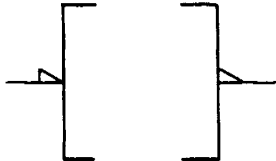

**Polarity Indicator**—The active state is a relatively low voltage level.

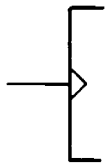

**Dynamic Indicator**—The active state is a transition from a relative low to a relative high voltage level.



**Inhibit Input**—Input that, when active, inhibits (blocks) the active state outputs of a digital device.

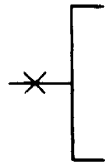

**Analog Input**—Input that is a continuous signal function (e.g., a sine wave).



**Polarity Indicator used with Inhibit Indicator**—Indicates that the relatively low level signal inhibits (blocks) the active state outputs of a digital device.

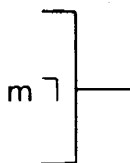

**Output Delay**—Binary output changes state only after the referenced input (m) returns to its inactive state (m should be replaced by appropriate dependency or function symbols).

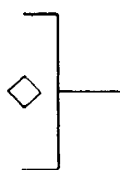

**Open Collector Output**—Output that must form part of a distributed connection.

**Figure 8-1. Schematic Diagram Notes (4 of 8)**

**DIGITAL SYMBOLOGY REFERENCE INFORMATION**

**Input and Output Indicators (Cont'd)**

**3-STATE** Three-state Output—Indicates outputs that can have a high impedance (disconnect) state in addition to the normal binary logic states.

**Combinational Logic Symbols and Functions**

**&** AND—All inputs must be active for the output to be active.

**≥1** OR—One or more inputs being active will cause the output to be active.

**≥m** Logic Threshold—m or more inputs being active will cause the output to be active (replace m with a number).

**=1** EXCLUSIVE OR—Output will be active when one (and only one) input is active.

**=m** m and only m—Output will be active when m (and only m) inputs are active (replace m with a number).

**=** Logic Identity—Output will be active only when all or none of the inputs are active (i.e., when all inputs are identical, output will be active).



**Amplifier**—The output will be active only when the input is active (can be used with polarity or logic indicator at input or output to signify inversion).

**X/Y**

**Signal Level Converter**—Input level(s) are different than output level(s).



**Bilateral Switch**—Binary controlled switch which acts as an on/off switch to analog or binary signals flowing in both directions. Dependency notation should be used to indicate affecting/affected inputs and outputs. Note: amplifier symbol (with dependency notation) should be read to indicate unilateral switching.

**X-Y**

**Coder**—Input code (X) is converted to output code (Y) per weighted values or a table.

**(Functional Labels)**

The following labels are to be used as necessary to ensure rapid identification of device function.

**MUX**

**Multiplexer**—The output is dependent only on the selected input.

**DEMUX**

**Demultiplexer**—Only the selected output is a function of the input.

**CPU**

**Central Processing Unit**

**PIO**

**Peripheral Input/Output**

**SMI**

**Static Memory Interface**

**Figure 8-1. Schematic Diagram Notes (5 of 8)**

**DIGITAL SYMBOLOGY REFERENCE INFORMATION**

**Sequential Logic Functions**



**Monostable**—Single shot multivibrator. Output becomes active when the input becomes active. Output remains active (even if the input becomes inactive) for a period of time that is characteristic of the device and/or circuit.



**Oscillator**—The output is a uniform repetitive signal which alternates between the high and low state values. If an input is shown, then the output will be active if and only if the input is in the active state.

**FF**

**Flip-Flop**—Binary element with two stable states, set and reset. When the flip-flop is set, its outputs will be in their active states. When the flip-flop is reset, its outputs will be in their inactive states.

**T**

**Toggle Input**—When active, causes the flip-flop to change states.

**S**

**Set Input**—When active, causes the flip-flop to set.

**R**

**Reset Input**—When active, causes the flip-flop to reset.

**J**

**J Input**—Analogous to set input.

**K**

**K Input**—Analogous to reset input.

**D**

**Data Input**—Always enabled by another input (generally a C input—see Dependency Notation). When the D input is dependency-enabled, a high level at D will set the flip-flop; a low level will reset the flip-flop. Note: strictly speaking, D inputs have no active or inactive states—they are just enabled or disabled.

**m**

**Count-Up Input**—When active, increments the contents (count) of a counter by “m” counts (m is replaced with a number).

**–m**

**Count-Down Input**—When active, decrements the contents (count) of a counter by “m” counts (m is replaced with a number).

**→ m**

**Shift Right (Down) Input**—When active, causes the contents of a shift register to shift to the right or down “m” places (m is replaced with a number).

**← m**

**Shift Left (Up) Input**—When active, causes the contents of a shift register to shift to the left or up “m” places (m is replaced with a number).

**NOTE**

*For the four functions shown above, if m is one, it is omitted.*

(Functional Labels)

The following functional labels are to be used as necessary in symbol build-ups to ensure rapid identification of device function.

**Figure 8-1. Schematic Diagram Notes (6 of 8)**



## DIGITAL SYMBOLOGY REFERENCE INFORMATION

### Sequential Logic Functions (Cont'd)

mCNTR	Counter—Array of flip-flops connected to form a counter with modulus $m$ ( $m$ is replaced with a number that indicates the number of states: 5 CNTR, 10 CNTR, etc.).
REG	Register—Array of unconnected flip-flops that form a simple register or latch.
SREG	Shift Register—Array of flip-flops that form a register with internal connections that permit shifting the contents from flip-flop to flip-flop.
ROM	Read Only Memory—Addressable memory with read-out capability only.
RAM	Random Access Memory—Addressable memory with read-in and read-out capability.

### Dependency Notation

mAm	Address Dependency—Binary affecting inputs of affected outputs. The $m$ prefix is replaced with a number that differentiates between several address inputs, indicates dependency, or indicates demultiplexing and multiplexing of address inputs and outputs. The $m$ suffix indicates the number of cells that can be addressed.
Gm	Gate (AND) Dependency—Binary affecting input with an AND relationship to those inputs or outputs labeled with the same identifier. The $m$ is replaced with a number or letter (the identifier).
Cm	Control Dependency—Binary affecting input used where more than a simple AND relationship exists between the $C$ input and the affected inputs and outputs (used only with D-type flip-flops).
Vm	OR Dependency—Binary affecting input with an OR relationship to those inputs or outputs labeled with the same identifier. The $m$ is replaced with a number or the letter (the identifier).
Fm	Free Dependency—Binary affecting input acting as a connect switch when active and a disconnect when inactive. Used to control the 3-state behavior of a 3-state device.

### NOTE

*The identifier ( $m$ ) is omitted if it is one—that is, when there is only one dependency relationship of that kind in a particular device. When this is done, the dependency indicator itself ( $G$ ,  $C$ ,  $F$ , or  $V$ ) is used to prefix or suffix the affected (dependent) input or output.*

Figure 8-1. Schematic Diagram Notes (7 of 8)

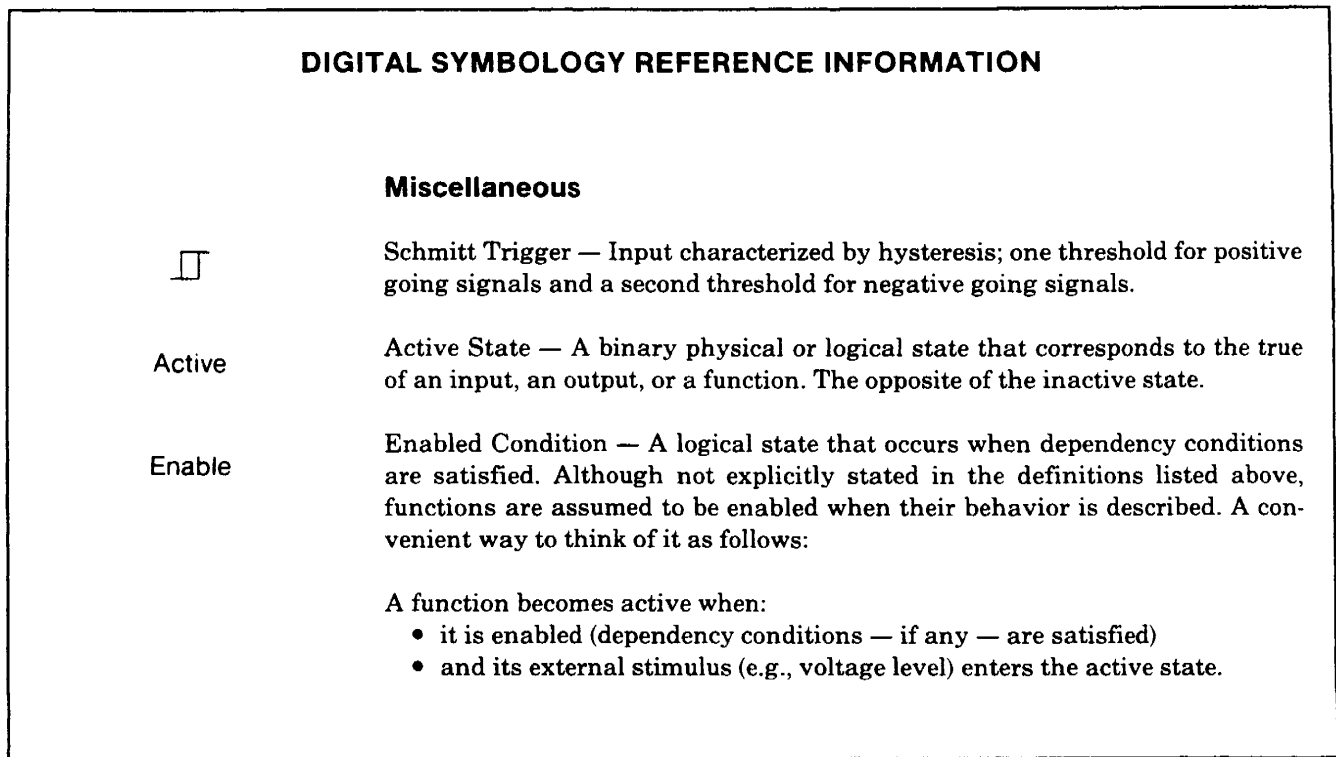

**Figure 8-1. Schematic Diagram Notes (8 of 8)**

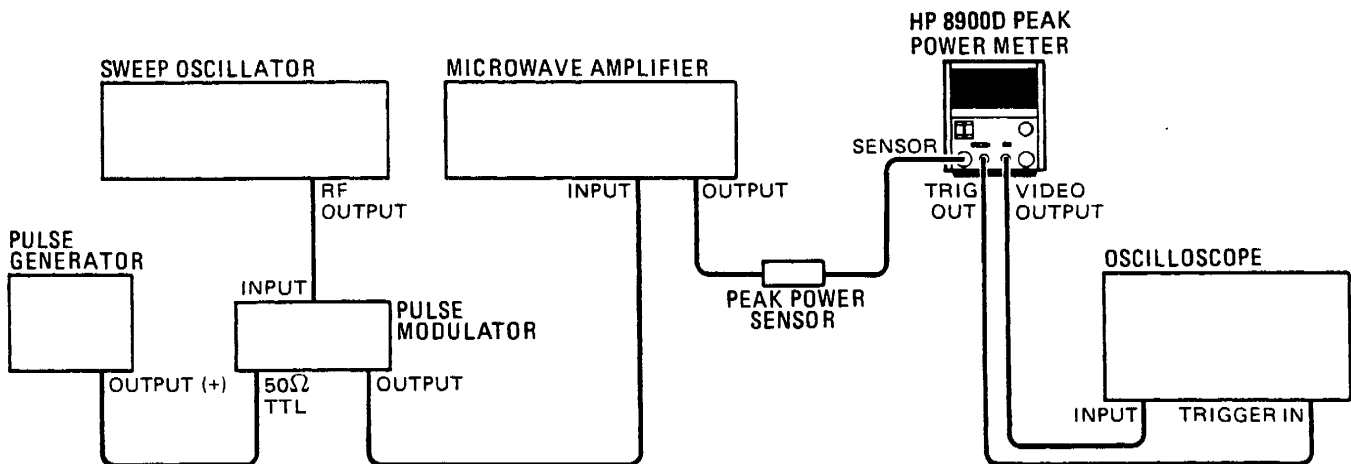

**Figure 8-2. Troubleshooting Equipment Setup**

**SERVICE SHEET BD1  
OVERALL BLOCK DIAGRAM  
PRINCIPLES OF OPERATION**

**General**

The Peak Power Meter Overall Block Diagram is shown in Figure 8-3. It shows the two major assemblies as well as the major circuits on each assembly.

The Peak Power Meter has two modes of operation. These are the Direct and Compare modes. In Direct mode, the Peak Detector circuit is used. In Compare Mode, the Trigger Amp, Video Amp, and FET switching circuits are used. Both modes use the 8X Amp, Shaper circuits, Shaper Output Amp, the Digital Panel Meter and Reading Offset circuits.

The explanations that follow briefly explain the function of some of the major circuits shown on the block diagram.

**Timing, Switch Driver, and FET Switch**

When the mode switch is in the Compare position, the Switch driver circuitry is enabled. This will cause the FET Switch to alternately switch the Sensor Input signal and the Compare Level to the Video Amp. This switching occurs at about a 70 Hz rate as controlled by the Timing circuit.

**Peak Detector**

When in Direct mode, the Peak Detector circuit will output a voltage corresponding to the most negative point on the Sensor Input pulse envelope.

**100 mW Shaper**

The 100 mW Shaper is functional when the Range switch is in the 100 mW position. Its function is to convert the non-linear dc signal from the previous circuitry to a linear dc signal. The linear signal can then be used by the digital meter.

**10 mW Shaper**

The function of the 10 mW Shaper is similar to the function of the 100 mW Shaper. It is functional when the Range switch is in the 10 mW position.

**Digital Panel Meter and BCD Output**

The function of the Digital Panel Meter and associated circuitry (shown on Service Sheet 3) is to convert an analog signal from the Shaper Assembly into BCD (Binary Coded Decimal) format. The BCD information is used to drive the digital display and rear panel BCD output. This output can be used to drive a peripheral device or interface with a computer.

**TROUBLESHOOTING**

1. Turn the instrument on. Observe the LINE switch indicator lamp. The lamp should be on.
2. Remove the instrument side covers. Check the  $+5.200V \pm 0.025V$  and  $-5.400V \pm 0.025V$  power supplies for proper voltage. If the lamp is not lit and the power supplies are within the limits specified, suspect a bad lamp. If the lamp is lit but the supplies are incorrect, suspect a problem in either the rectifying or regulating circuitry. In either case, go to the schematic diagram on Service Sheet 1 to continue troubleshooting.
3. Set the front panel controls on the Peak Power Meter as follows:
 

Correction .....	50
Range .....	100 mW
Mode .....	Direct
4. Connect a 50Ω potentiometer in series with the negative output of the dc power supply. Connect the 50Ω potentiometer to the terminal with the green wire (color coded 5) on the CORRECTION control and adjust the power supply and potentiometer for an output of  $-0.5610 \pm 0.0005V$ .
5. Measure the voltage at J4, the Recorder Output, with a digital voltmeter. The voltage at this point should be  $+1.000 \pm .005V$ . If this voltage is correct, go to the schematic on Service Sheet 3 to continue troubleshooting. Otherwise, continue to the next step.
6. Set the MODE switch to COMPARE, and vary the COMPARE LEVEL control. The meter should change value as the COMPARE LEVEL control is varied. If the meter does not change value, go to Service Sheet 1 to continue troubleshooting.
7. Set the MODE switch to DIRECT. Set the RANGE switch to 10 mW. Using a dc power supply, apply  $-0.162$  volts to the terminal with the green wire (color coded 5) on the CORRECTION control located behind the front panel. The meter should display full scale deflection. If all is correct, continue with the next step. Otherwise, go to Service Sheet 1 Troubleshooting, step 1 to continue troubleshooting.
8. Disconnect the dc power supply from the green wire on the CORRECTION control. Set MODE switch to COMPARE and set the Range Switch to 100 mW. Set up the equipment as shown in Figure 8-2.

**SERVICE SHEET BD1 (cont'd)**

9. Apply a known pulsed microwave signal of 50 mW to the peak power sensor. This signal should have a pulse rate of 1 kHz and a pulse width of 1  $\mu$ s. The pulse modulated frequency can be anywhere within the range of 100 MHz to 18 GHz. The oscilloscope should show a "dual trace" consisting of the envelope of the input pulse along with a line that should move as the COMPARE LEVEL control is varied. If all is correct, continue to the next step. Otherwise, go to Service Sheet 1 Troubleshooting, step 6 to continue troubleshooting.

10. Set the MODE switch to DIRECT. Set the CORRECTION factor to whatever CORRECTION factor is listed on the peak power sensor for the pulse modulated frequency set in step 6. Check for a power level indication of 50 mW on the meter. Vary the pulse power level from 1 to 100 mW. The level shown on the meter should track the peak power level of the input signal. If an incorrect reading is observed at any power level, go to Service Sheet 2 Troubleshooting to continue troubleshooting. If no problem has revealed itself, either the instrument is working properly, the problem is intermittent or a subtle deviation from specifications not checked in this procedure.

**Table 8-1. Troubleshooting Voltages**

INPUT	J1 Pin 1	A3TP11	A2TP1	A2TP3
100 mW	-0.5562V	+3.00 $\pm$ 0.06V	+3.00 $\pm$ 0.06V	+1.000 $\pm$ 0.005V
10 mW	-0.1605V	+0.865 $\pm$ 0.017V	+0.865 $\pm$ 0.017V	+1.0000 $\pm$ 0.0005V

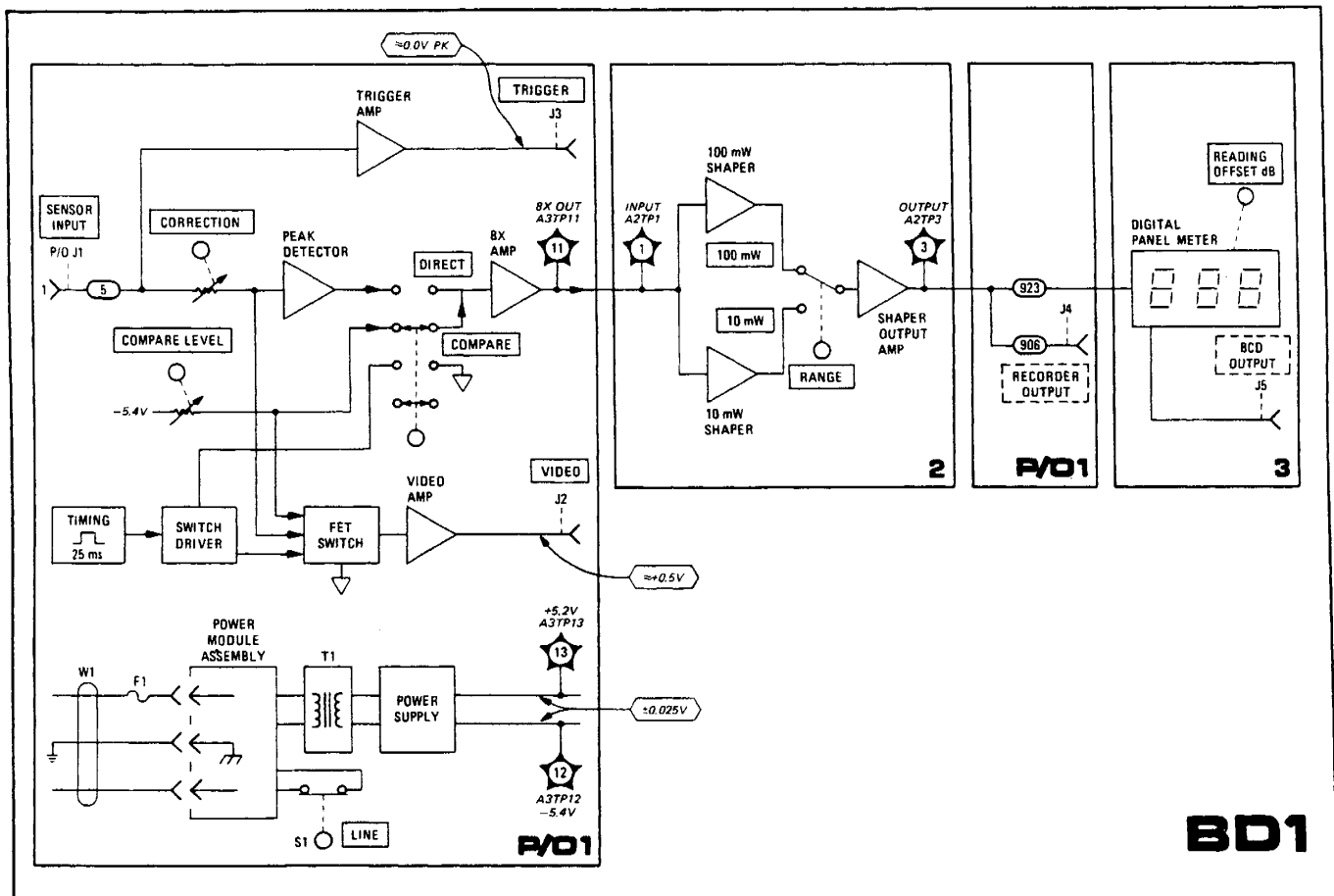

**Figure 8-3. Troubleshooting Block Diagram**

**SERVICE SHEET 1  
MOTHERBOARD**

**PRINCIPLES OF OPERATION**

**General**

The schematic diagram for Service Sheet 1 shows the power supply circuitry and most of the signal path from the input to the A/D Converter. The shaper circuitry is shown on Service Sheet 2. The VIDEO and TRIGGER outputs, and related circuits, are also shown on this service sheet.

**Neg Peak Detector**

When in Direct Mode, this circuit is used. The signal enters U1 which is a non-inverting amplifier. Capacitor C1 allows the amplifier's gain to increase as input frequency increases. The output of this amplifier charges capacitor C8. Several cycles of the input pulse are needed to fully charge this capacitor. The capacitor is charged to a potential equal to the pulse peak value multiplied by the gain of the U1 circuit. Resistor R17 serves to discharge C8 once the input signal is removed.

**Trigger Amp**

The input to the TRIGGER AMPLifier is taken directly from the output of the peak power sensor. This amplifier has an inverted output with a gain of about 30. It will work with inputs of 0.1 mW or more. Typically, once the input exceeds 2 mW, the output of the amplifier will not change much.

**8X Invert Amp**

The input to the 8X INVERT AMP comes from the output of the NEG PEAK DETECTOR when in Direct mode or from the COMPARE LEVEL potentiometer when in Compare mode. The first stage is a non-inverting amplifier with a gain of about 7. The second stage is an inverting amplifier with a gain of about 1.1. The purpose of this amplifier is to provide enough power to drive the shaper circuit (Service Sheet 2).

**Switch Driver and FET Switch**

The SWITCH DRIVER is made up of U4A, U4B, U5 and associated circuitry. U5 is a timer circuit that is set to output a clock signal at a 25 ms period. This signal clocks the circuit that is made up of U4A and U4B, a frequency divide-by-4 circuit. The two outputs of the second divider drive

the FET SWITCH. The FET SWITCH will either pass the signals or break the signal path, depending on the status of the F inputs (A low on an F input will allow the signal to pass; a high will prevent the signal from passing). When the COMPARE LEVEL voltage is being passed through the switch, the collector of Q3 will short to ground, shorting the input pulse. This way, none of the input signal will be coupled onto the COMPARE LEVEL voltage when it is viewed on the oscilloscope.

**TROUBLESHOOTING**

1. Set the front panel controls on the Peak Power Meter as follows:
 

Correction .....	50
Range .....	100 mW
Mode .....	Direct
2. Connect a 50Ω potentiometer in series with the negative output of the dc power supply. Connect the 50Ω potentiometer to the terminal with the green wire (color coded 5) on the CORRECTION control and adjust the power supply and potentiometer for an output of  $-0.5610 \pm 0.0005V$ .
3. Measure the voltage at A3TP11. The voltage at this point should be  $+3.00 \pm 0.06V$ . If the voltage at this point is incorrect, continue to the next step. Otherwise, go to Service Sheet 2 Troubleshooting to continue troubleshooting.
4. Measure the voltage at A3TP5. The voltmeter should read  $-0.376 \pm 0.01V$ . If the voltage reading is correct, troubleshoot the 8X INVERT AMP. Otherwise, continue to the next step.
5. Measure the voltage at A3P1 pin 4. The voltmeter should read  $-0.413 \pm 0.01V$ . If the voltage at this point is correct, troubleshoot the NEG PEAK DETECTOR. Otherwise, troubleshoot A1R3, the CORR ADJ potentiometer, and associated circuitry.
6. Probe the output of the TRIGGER AMP circuit with the oscilloscope. The oscilloscope should show a pulse with an amplitude  $>0.1V$  occurring at the beginning of the sweep cycle of the oscilloscope. If no pulse is seen or if the pulse amplitude is lower than specified, troubleshoot the TRIGGER AMP. Otherwise, continue to the next step.

**SERVICE SHEET 1 (cont'd)**

7. Measure the voltage at A3U4 pin 11 with a dc voltmeter. The voltage should be a TTL high (that is,  $>+2V$ ). If all is correct, continue to the next step. Otherwise, troubleshoot A1S2 and A3R40.
8. Probe pins 9 and 10 of A3U4 with the oscilloscope. The oscilloscope display should show a TTL signal with a period of approximately 25 ms on each of the pins. If these signals are correct, continue to the next step. Otherwise, troubleshoot the SWITCH DRIVER circuit.
9. Connect the oscilloscope to A3TP7. The signal at this point should be a negative-rectified version of the power sensor output. If the signal is correct, continue to the next step. Otherwise, troubleshoot the peak power sensor (see the HP 84811A Peak Power Sensor Operating and Service Manual).
10. Connect the dc voltmeter to A3U3 pin 11. Vary the COMPARE LEVEL control. The voltage should vary from about 0V to about  $-0.538V$ . If the voltage changes correctly, continue to the next step. Otherwise, troubleshoot potentiometer R1 and associated circuitry.
11. Connect the oscilloscope to A3TP6. Set the COMPARE LEVEL knob on the Peak Power Meter fully clockwise. The oscilloscope should show a dc level of  $-0.5V$  and the negative-rectified input pulse with an amplitude of  $-0.08V$ . If these voltages are correct, troubleshoot the VIDEO AMP. Otherwise, troubleshoot the FET SWITCH.

## Regional Sales and Support Offices

US FIELD OPERATIONS			
<b>Headquarters</b> Hewlett-Packard Co. 19320 Pruneridge Ave. Cupertino, CA 95014 (800) 752-0900	<b>California, Northern</b> Hewlett-Packard Co. 301 E. Evelyn Mountain View, CA 94041 (415) 694-2000	<b>California, Southern</b> Hewlett-Packard Co. 1421 South Manhattan Ave. Fullerton, CA 92631 (714) 999-6700	<b>Colorado</b> Hewlett-Packard Co. 24 Inverness Place, East Englewood, CO 80112 (303) 649-5512
<b>Atlanta Annex</b> Hewlett-Packard Co. 2124 Barrett Park Drive Kennesaw, GA 30144 (404) 648-0000	<b>Illinois</b> Hewlett-Packard Co. 5201 Tollview Drive Rolling Meadows, IL 60008 (708) 255-9800	<b>New Jersey</b> Hewlett-Packard Co. 150 Green Pond Rd. Rockaway, NJ 07866 (201) 586-5400	<b>Texas</b> Hewlett-Packard Co. 930 E. Campbell Rd. Richardson, TX 75081 (214) 231-6101
EUROPEAN FIELD OPERATIONS			
<b>Headquarters</b> Hewlett-Packard S.A. 150, Route du Nant-d'Avril 1217 Meyrin 2/Geneva Switzerland (41 22) 780.8111	<b>France</b> Hewlett-Packard France 1 Avenue Du Canada Zone D'Activite De Courtaboeuf F-91947 Les Ulis Cedex France (33 1) 69 82 60 60	<b>Germany</b> Hewlett-Packard GmbH Hewlett-Packard Strasse 61352 Bad Homburg v.d.H Germany (49 6172) 16-0	<b>Great Britain</b> Hewlett-Packard Ltd. Eskdale Road, Winnersh Triang Wokingham, Berkshire RG41 5 England (44 1734) 696622
INTERCON FIELD OPERATIONS			
<b>Headquarters</b> Hewlett-Packard Company 3495 Deer Creek Road Palo Alto, California, USA 94304-1316 (415) 857-5027	<b>Australia</b> Hewlett-Packard Australia Ltd. 31-41 Joseph Street Blackburn, Victoria 3130 (61 3) 895-2895	<b>Canada</b> Hewlett-Packard (Canada) Ltd. 17500 South Service Road Trans-Canada Highway Kirkland, Quebec H9J 2X8 Canada (514) 697-4232	<b>China</b> China Hewlett-Packard Company 36 Bei San Huan X1 Road Shuang Yu Shu HaiDian District Beijing, China (86 1) 256-6888
<b>Japan</b> Hewlett-Packard Japan, Ltd. 1-27-15 Yabe, Sagami-hara Kanagawa 229, Japan (81 427) 59-1311	<b>Singapore</b> Hewlett-Packard Singapore (Pte.) Ltd. 150 Beach Road #29-00 Gateway West Singapore 0718 (65) 291-9088	<b>Taiwan</b> Hewlett-Packard Taiwan 8th Floor, H-P Building 337 Fu Hsing North Road Taipei, Taiwan (886 2) 712-0404	



Printed in UK

Manufacturing Part Number

**08900-90249**

